

X MIND trium

USER MANUAL



ENGLISH

MANUFACTURER

de Götzen® S.r.l. - a company of ACTEON Group

Via Roma, 45
21057 OLGiate OLONA (VA) - ITALY
Tel. +39 0331 376760
Fax +39 0331 376763

www.acteongroup.com

FOR INFORMATION AND TECHNICAL ASSISTANCE, CONTACT YOUR LOCAL ACTEON

AUSTRALIA NEW ZEALAND	AUTHORIZED SPONSOR ACTEON AUSTRALIA/NEW ZEALAND info@au.acteongroup.com
CANADA	REGULATORY CORRESPONDENT ACTEON INC info@us.acteongroup.com
CHINA	ACTEON CHINA beijing@cn.acteongroup.com
FRANCE	SOPRO - ACTEON GROUP cs@acteongroup.com
GERMANY	ACTEON GERMANY info@de.acteongroup.com
INDIA	ACTEON INDIA info@in.acteongroup.com
ITALY	ACTEON ITALIA info@it.acteongroup.com
JAPAN	MHA Market Authorization Holder Hakusui Trading Co., Ltd.
MIDDLE EAST	ACTEON MIDDLE EAST info@me.acteongroup.com
RUSSIA	ACTEON RUSSIA info@ru.acteongroup.com
SPAIN	ACTEON MEDICO-DENTAL IBERICA info@es.acteongroup.com
SOUTH AMERICA	ACTEON LATIN AMERICA info@es.acteongroup.com
TAIWAN	ACTEON TAIWAN info@tw.acteongroup.com
THAILAND	ACTEON THAILAND info@th.acteongroup.com
U.K.	ACTEON UK info@uk.acteongroup.com
USA	INITIAL IMPORTER / US AGENT ACTEON INC info@us.acteongroup.com

OR THE MANUFACTURER AT
imaging.italysupport@acteongroup.com

ENGLISH

Language of the original document: ENGLISH

Important: All new editions and revisions of the manuals supersede the previous ones



Refer to complete manuals and instructions



For complete manuals and instructions
www.aceongroup.com



Scan the QR code to access the dedicated website
www.aceongroup.com

ENGLISH

CONTENTS

INTRODUCTION	6
1.1 CAUTIONS	6
1.3 IDENTIFICATION TAGS	8
1.4 POSITION OF THE IDENTIFICATION LABELS	11
1.5 STANDARDIZED SYMBOLS	12
DESCRIPTION	13
2.1 OPERATOR'S WORKSTATION	13
2.2 X-MIND TRIUM REMOTE CONTROL	13
2.3 X-MIND TRIUM MEDICAL DEVICE	14
2.4 X-MIND TRIUM CONFIGURATIONS	16
2.5 EXAMS	16
2.6 CONTROL PANELS	18
2.7 KEYS DESCRIPTION	19
2.8 LIGHT INDICATORS	20
2.9 X-MIND TRIUM REMOTE CONTROL	20
2.10 EMERGENCY SWITCHES	21
2.11 X-RAY EXPOSURE SWITCH	22
2.12 HEAD SUPPORT FOR PAN/CBCT EXAMS	22
2.13 HEAD SUPPORT FOR CEPH EXAMS	22
2.14 ACCESSORIES	23
SWITCHING ON / OFF THE SYSTEM	25
3.1 SWITCHING ON	25
3.2 SWITCHING OFF	26
PRE ACQUISITION	27
4.1 PREPARING THE SYSTEM	27
4.2 CREATING OR SELECTING PATIENT DATA	27
4.3 INSTRUCTING THE PATIENT	27
4.4 POSITIONING THE PATIENT FOR PAN/CBCT EXAMS	28
PAN ACQUISITION	30
5.1 SELECTING THE EXAM TYPE	30
5.2 PATIENT POSITIONING	31
5.3 EXECUTION OF THE PAN EXAM	33
CBCT ACQUISITION	34
6.1 SELECTING THE EXAM TYPE	34
6.2 PATIENT POSITIONING	37
6.3 EXECUTION OF THE CBCT EXAM	38
CEPH ACQUISITION	40
7.1 SELECTING THE EXAM TYPE	40
7.2 PATIENT POSITIONING	40
7.3 EXECUTION OF THE CEPH EXAM	42

ENGLISH

RELEASING THE PATIENT	43
MAINTENANCE, CLEANING AND DISPOSAL	44
9.1 MAINTENANCE	44
9.2 CLEANING	44
9.3 DISPOSAL	44
TROUBLESHOOTING	45
10.1 ERROR CODES AND REQUIRED ACTIONS	45
10.2 TRIUM ERRORS	46
ANNEXES	55
11.1 DEVICE POWER SUPPLY	55
11.2 ELECTRICAL CLASSIFICATION (IEC 60601-1)	55
11.3 X-RAY ASSEMBLY AND X-RAY TUBE	55
11.4 DEGREE OF PROTECTION PROVIDED BY ENCLOSURES	57
11.5 DEVICE MECHANICAL DATA	58
11.6 WORKSTATION FEATURES	58
11.7 DETECTORS	58
11.8 SCANNING PARAMETERS – PAN/CEPH	59
11.9 SCANNING PARAMETERS – CBCT	59
11.10 LASER	60
11.11 FIRMWARE DATA	60
11.12 CLIENT PC MINIMUM REQUIREMENTS	60
11.13 INTENDED ENVIRONMENT	61
11.14 DIMENSIONS OF THE UNIT	61
11.15 LIST OF INTERNATIONAL STANDARDS AND DIRECTIVES	63
11.16 DOSIMETRIC INDICATIONS	63
11.16.2 DOSIMETRIC INDICATIONS IN TERMS OF CTDI (FOR CBCT EXAMS)	74
11.17 ELECTROMAGNETIC COMPATIBILITY	82
11.17.1 RECOMMENDED SEPARATION DISTANCES	82
11.17.2 ELECTROMAGNETIC EMISSIONS	82
11.17.3 ELECTROMAGNETIC IMMUNITY	83
11.17.4 ELECTROMAGNETIC IMMUNITY, HANDHELD RADIOFREQUENCY EQUIPMENT	84
WARNINGS	85
INTERACTIONS CONTRAINDICATIONS PROHIBITIONS	88

INTRODUCTION

Thank you for choosing the X-MIND trium.

The electro medical equipment described in this manual refers to the X-Mind trium medical device.

X-MIND trium is a radiological device and must be used and handled only by specialised surgeons, dentists and authorised and duly trained personnel, who meet the requirements provided by the national laws in force in the country of installation. The training and preparation of personnel must be included in the tasks of the responsible organization.

Before using the X-MIND trium, the operator must read and understand all the instructions provided in the manual in order to obtain the highest performance and ensure the safety of patients, of operators, of the medical device and the environment.

X-MIND trium is a digital panoramic, cephalometric and tomographic extra-oral X-ray system, indicated for use in:

- producing panoramic X-ray images for diagnostic examination of dentition (teeth), jaws and oral structures;
- producing radiographs of maxillofacial region and parts of the skull for cephalometric examination, if equipped with CEPH arm;
- producing radiographs of hands and wrists for carpus examination, if equipped with CEPH arm;
- producing tomographic images of the oral and maxillofacial region, for diagnostic examination of dentition (teeth), jaws, oral structures and some cranial bones, if equipped with CBCT option.

This medical device complies with the essential requirements of European Directive 93/42/EEC. This equipment is designed and developed in compliance with Electrical Safety standard IEC 60601-1 in force. It was designed and manufactured in accordance with an EN ISO 13485-certified quality assurance system and Good Manufacturing Practices (21 CFR 820).

From a clinical point of view, the X-MIND trium can be applied for the following medical applications:

- Generic dentistry
- Dental implantology
- Dental surgery
- Maxillo-facial surgery
- Cephalometric analysis
- Carpus radiology

The target patient population includes adults and pediatric patients from 5 years old [-21 kg (46 lb); 113 cm (44.5 in) standing height]; anyway the sustainability to X-ray exposure must be evaluated by surgeons, dentists and qualified and authorized physicians.

The intended user profile is a qualified, trained and authorized physician or dentist who meets the requirements provided by national laws in force in the country of installation; the operator must understand the language of the country where the device is installed.

Contraindications:

- Viewing cartilaginous structures;
- The CBCT technique has a limited capability of detecting soft tissues.

1.1 CAUTIONS

CAUTION :

CAUTION messages refer to circumstances that can jeopardise the operator's safety, cause injuries to operators and patients or damage the medical device and the environment.

WARNING :

WARNING messages refer to circumstances that can compromise the performance of the X-MIND trium medical device.

NOTE :

NOTE messages provide indications for easier maintenance and highlight important information.

1.1 MANUFACTURER RESPONSIBILITY

The manufacturer shall under no circumstances be held liable for injuries to persons or damage to property caused by:

- Non-compliance with manufacturer recommendations during installation, whether this is the network voltage or the electromagnetic environment,
- Maintenance or repair procedures performed by people who are unauthorized by the manufacturer,
- Use on an electrical fixture that is not compliant with regulations in force,
- Uses other than those specified in this manual.
- Use of accessories (temple rest, chin rest, bites, etc.) other than those supplied by ACTEON Imaging,
- Use of hygienic protections different from class I Medical Device Directive 93/42/EEC and subsequent amendments or not compliant with ISO 10993 series of standards.
- Non-compliance with the instructions contained in the accompanying documents.

Note: the manufacturer reserves the right to modify the medical device and/or any documentation without notice.

1.2 WARRANTY

Any improper use or unauthorised modification to the medical device shall relieve the manufacturer of the medical device, from the obligation to provide assistance covered by warranty and from any liability. This will also result in additional charges for technical assistance not covered by warranty.

The warranty is valid only if the following requirements are complied with:

- Repairs, modifications, adjustments and calibrations must be carried out solely by ACTEON Group or by qualified, authorised and/or trained personnel.
- Installation must be carried out by qualified and trained technicians in compliance with the standards in force and as recommend by the manufacturer.
- This medical device must be installed and used following the instructions provided in the installation manual and in the attached documents.
- The mains power supply must provide the required power and its characteristics must meet the specifications indicated on the medical device identification label.
- The medical device must be periodically inspected by qualified, authorized and trained technical personnel in compliance with the standards in force and with the manuals provided by the manufacturer.

ENGLISH

Terminology used in the manual:





TERM	MEANING
AOR	Axis Of Rotation. Axis of rotation of the U-Arm.
CBCT	Medical device that acquires radiological images, using a cone radiation beam and reconstructs the 3D volume of the scan.
CEPH	Is the common name for Cephalometry or Cephalostat.
DGI	Proprietary file format used to save digital radiological projections.
DICOM	Digital Imaging and Communications in Medicine. Medical imaging standard that defines the rules and criteria to transfer, view, store and print information in medical imaging, in order to ensure communication between medical devices and information systems.
FOV	Field Of View. The volume scanned and reconstructed by the X-MIND trium medical device.
FPD	Flat Panel Detector. 2-dimensional digital detector to acquire radiographic projections.
PAN	Is the common name for panoramic image or Orthopantomogram.
ROI	Region of Interest. Patient's anatomical area to be examined and segmented in a tomographic image.
HU	Hounsfield Unit. Standard reference scale used to describe radiodensity in systems.
AIS	Acteon imaging Suite software that manages all the functional aspects of the X-MIND trium system, including: patient database, patient acquisition, calibrations, quality tests, maintenance, display that allows the operator to make the diagnosis and treatment planning.

1.3 IDENTIFICATION TAGS

X-MIND TRIUM LABEL

X-MIND trium **REF** W0900006
de Götzen® S.r.l
 Via Roma 45 21057
 Olgiate Olona (VA) – ITALY  2018-03 **CE** 2460





Line voltage: 100-240 V ~ 50-60 Hz
Input power: 1500 VA Class I 



SN  www.acteongroup.com    

 Complies with DHHS radiation performance standards 21 CFR Subchapter J

X-RAY ASSEMBLY label

X-ray source assembly **Type: X-MIND trium**
de Götzen® S.r.l
 Via Roma 45 21057
 Olgiate Olona (VA) – ITALY  2018-03 **CE** 2460

Max anodic voltage 90 kVp **Max anodic current:** 10 mA
Tot filtr: PAN/CEPH 2.8mmAl/85kVp - CBCT 7.0mmAl/90kV
Focus:  0.5 mm **X-ray tube:** OPX/105   



SN  tube: **SN** 

Complies with DHHS radiation performance standards 21 CFR Subchapter J



ENGLISH

X-RAY BEAM LIMITER label





Beam Limiting Device Type: X-MIND trium  **2460**

 **de Götzen® S.r.l**
Via Roma 45 21057
Olgiate Olona (VA) – ITALY  2018-03

Total filtration PAN/CEPH ver.: 2.8mm Al / 85 kVp
Total filtration CBCT ver.: 7.0 mmAl / 90 kVp

Complies with DHHS radiation performance standards 21 CFR Subchapter J
CAUTION X-RAYS LABEL

CAUTION X-RAYS DANGER RAYONS X	
CAUTION: FEDERAL LAW RESTRICTS THIS DEVICE TO SALE BY OR ON THE ORDER OF A PHYSICIAN	
<p>TO BE OPERATED ONLY BY TRAINED AND AUTHORIZED PERSONNEL. SEE OPERATOR'S INSTRUCTIONS. <i>L'UTILISATION DOIT ÊTRE EFFECTUÉE SEULEMENT PAR LE PERSONNEL QUALIFIÉ ET AUTORISÉ.</i> RESPECTER LES INSTRUCTIONS DE L'OPÉRATEUR.</p>	
<p>WARNING - This X-ray equipment may be dangerous for both the patient and the operator unless safe exposure factors and operating instructions are observed. ATTENTION - Cet appareil à rayons x peut être dangereux pour le patient et pour l'opérateur. Pour éviter toute forme de risque il faut respecter les règles de sécurité et suivre les instructions de fonctionnement.</p>	
  	

CAUTION LASER BEAM LABEL

	<p>CAUTION</p> <p>LASER RADIATION AVOID DIRECT EYE EXPOSURE CLASS 3R LASER PRODUCT</p> <p>RAYONNEMENT LASER EXPOSITION DIRECTE DANGEREUSE POUR LES YEUX APPAREIL À LASER DE CLASSE 3R</p> <p><small>Maximum output: 2 mW. Wavelengths: 635-650 nm IEC 60825-1:2007</small></p>
---	---

FRANKFURT LASER APERTURE









IEC 107514

Please see section 11.11 for more details



	<p>X-MIND trium is a class 3R laser product. Avoid direct eye exposure to laser radiation. Viewing the laser output with telescopic optical instruments (for example, telescopes and binoculars) may pose an eye hazard and thus the user should not direct the beam into an area where such instruments are likely to be used</p> <p>Use of controls or adjustments or performance of procedures other than those specified herein may result in hazardous radiation exposure</p>
---	---

PAN DETECTOR LABEL

PAN detector Type: X-MIND trium  2460	
 de Götzen® S.r.l Via Roma 45 - 21057 Olgiate Olona (VA) – ITALY 2015-02	
<hr/>	
 Detector:	  
Conforms to DHHS radiation performance standards 21 CFR Subchapter J	

ENGLISH

REMOVABLE DETECTOR LABEL



Removable detector Type: X-MIND trium 
 **de Götzen® S.r.l.**
Via Roma 45 - 21057 Olgiate Olona (VA) – ITALY
2018-03

SN Detector:



Conforms to DHHS radiation performance standards 21 CFR Subchapter J

3D DETECTOR LABEL



3D detector Type: X-MIND trium 
 **de Götzen® S.r.l.**
Via Roma 45 - 21057 Olgiate Olona (VA) – ITALY
2018-03

SN Detector:



Conforms to DHHS radiation performance standards 21 CFR Subchapter

CEPH ARM LABEL

CEPH Arm Type: X-MIND trium 
 **de Götzen® S.r.l.**
Via Roma 45 - 21057 Olgiate Olona (VA) – ITALY
2018-03

SN



Conforms to DHHS radiation performance standards 21 CFR Subchapter

ETL MARKING

ETL CLASSIFIED	CONFORMS TO
	ANSI/AAMI ES 60601-1
	IEC STD 60601-1-3
	IEC STD 60601-1-6
	IEC STD 60601-2-63
	IEC STD 62366
Intertek	CERTIFIED TO
4002197	CSA STD 22.2 NO. 601-1

UDI LABEL

X-MIND trium

XMT PAN R

REF W0900001 **SN** XT01009C

UDI CODE







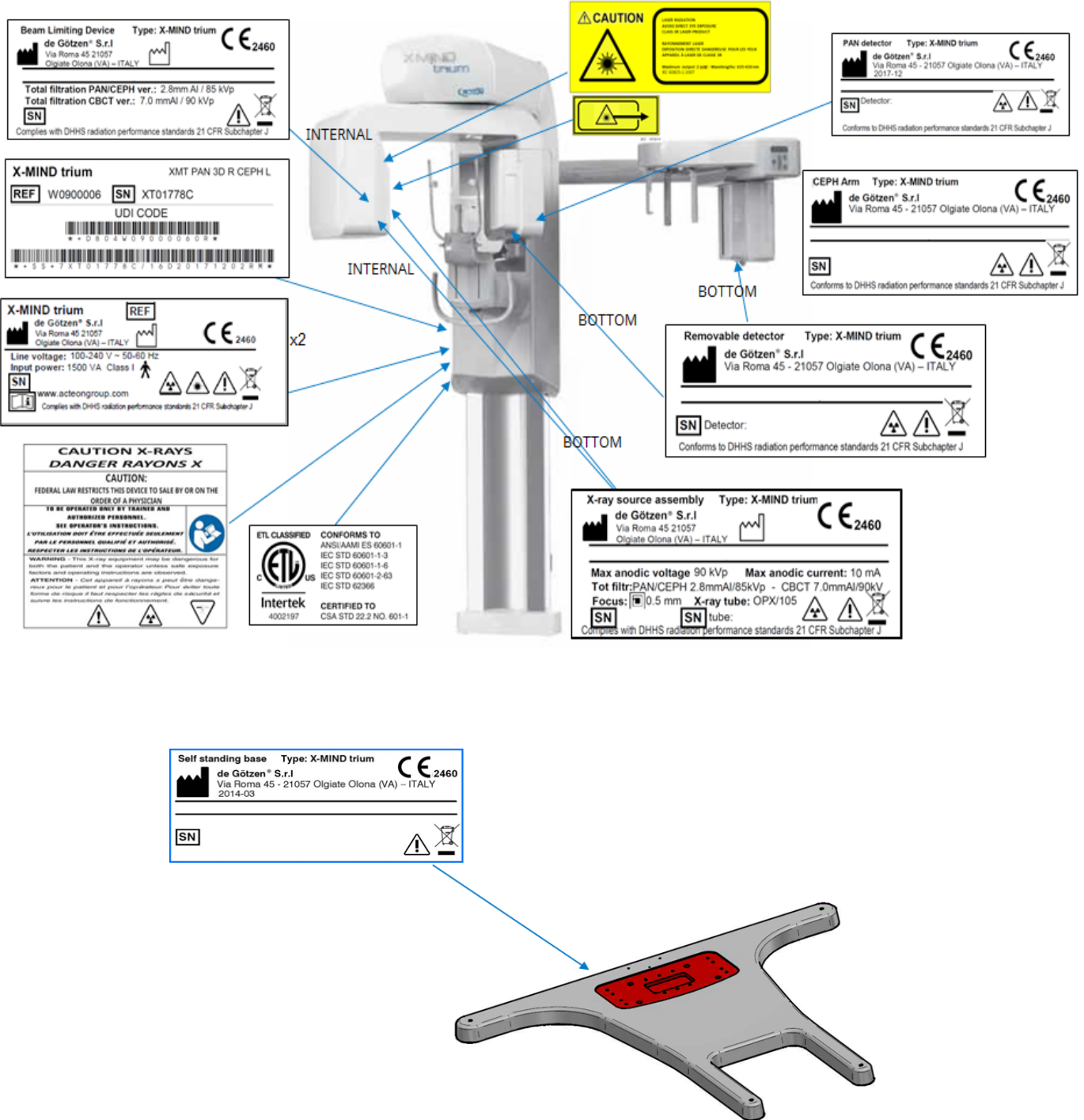















ENGLISH

1.4 POSITION OF THE IDENTIFICATION LABELS



ENGLISH

1.5 STANDARDIZED SYMBOLS

	En: Power ON (IEC 60417)
	En: Power OFF (IEC 60417)
	En: Protective earth (IEC 60417)
	En: Alternating current (IEC 60417)
	En: Applied Part: Type B (IEC 60601-1)
	Attention, refer to the attached documents
	Ionising radiation hazard
	Emitting X-ray equipment (IEC 60417)
	Laser beam hazard (ISO 3864)
	Laser beam aperture
	Do not dispose of a household waste
	Size of the focal spot (small)
	Hazardous Voltage
	Emergency Stop Command
	Electrostatic discharge sensitive device
	Pause
	X-ray command
	This symbol guarantees that the x-ray system complies with the regulations contained in the European directive 93/42/EEC and subsequent amendments regarding medical devices.
	This symbol reminds that is mandatory to carefully read the whole documentation and manuals provided with the medical device before to perform whatever operation.
	Electronic instructions for use symbol for medical devices, according to EN ISO 15223-1: 2016

DESCRIPTION

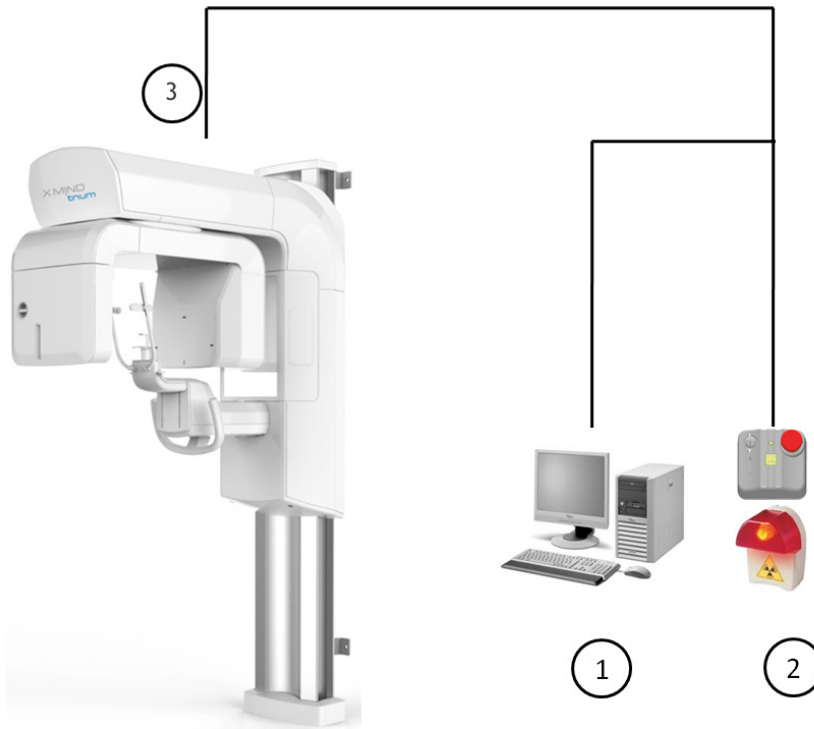

The X-MIND trium medical device system consists of:

2.1 OPERATOR'S WORKSTATION

The operator's workstation is provided optionally for the PAN only unit.

The workstation allows the operator to perform the following procedures:

- Calibrations of the medical device
- Acquisition parameters setting
- Radiological image acquisition
- Image visualization and post processing
- Database management
- Periodic quality Tests

The workstation must have installed the following modules:

- ACTEON IMAGING SUITE (AIS) equipment management software + 2D diagnostic analysis
- AIS 3D app (CBCT)

Communication with the medical device occurs by means of Ethernet protocol.

2.2 X-MIND TRIUM REMOTE CONTROL

The X-MIND trium remote control must be located in a safe place protected against radiations, in compliance with the local standards in force concerning ionising radiation protection.

The X-MIND trium remote control allows the operator to activate or deactivate X-ray emission from the control room. This consists of two switches, one for exposure and one for emergency, which control device operation.

X-MIND trium Light



The X-MIND trium Light is an indicator light that warns that X-ray emission is in progress. It indicates no entry into the room when the red light is on; it also has a triangular danger sign that warns of X-ray hazards.

2.3 X-MIND TRIUM MEDICAL DEVICE

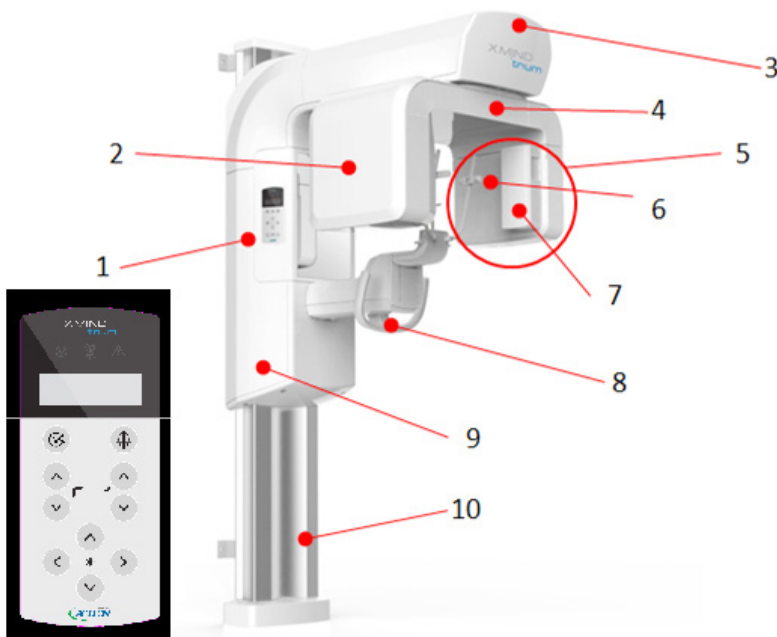

The X-MIND trium medical device for PAN/CBCT models consists of the following parts:

1. Control panel. The control panel provides an intuitive overview of the system to move the mobile column, move the bite block holder (only PAN/CBCT version), move the U-arm, turn the positioning lasers on and off and activate the X-MIND trium medical device.
2. X-ray generator. The X-ray assembly is the source of the X-ray beam during the rotation of the U-Arm. An automatic collimator shapes the X-Ray beam, whereas the electronic control ensures stability and accuracy of the selected loading factors (exposure time, kVp and anodic current). A filter is used to harden the beam and remove low-energy ionising radiations, thereby obtaining suitable radiation quality whilst reducing its dose absorbed by the patient. The filter's material is aluminium for PAN and CEPH exams, aluminium + copper for CBCT exams.
3. Sliding body. The sliding body is the mobile part of the column that supports U-arm.
4. U-arm. The U-Arm supports the PAN/CBCT Detector sliding group and the X-ray generator. This is the rotating part of the medical device, which moves around the patient during the image acquisition phase ; it can as well be moved in two horizontal directions (X and Y) by the operator during the setup of the exam, in order to obtain the best superimposition between the patient's head anatomy and the diameter of the Field of View (FOV).
5. Detector sliding group. It contains detectors that allow to acquire PAN and CBCT images.
6. CBCT detector. This flat panel detector is indicated for use in generating radiographic images of the maxillo-facial region, more specifically it is dedicated for CBCT acquisitions.

7. PAN detector. This flat panel detector is indicated for use in generating radiographic images of the maxillo-facial region, more specifically it is dedicated for PAN acquisitions.
8. Patient support. The patient support allows stabilising and immobilising the patient. It can be moved vertically in order to obtain the best superimposition between the patient's head anatomy and the height of Field of View (FOV).
9. F group. It is the whole assembled mobile group of the device. It is the moving part of the medical device, which adapts the acquisition geometry to the patient's anatomy and stance (sitting or standing). It supports the U-Arm and head support
10. Column. The fixed column supports the entire structure of the medical device. This contains the motor that raises the F Group.

Overview of the medical device: **Cephalometric extension:**

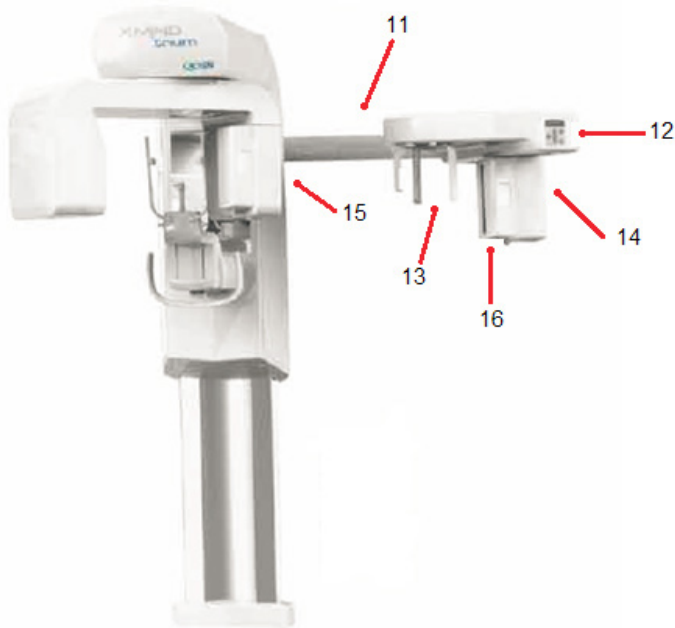

The Cephalometric version of X-MIND trium medical device consists of the parts listed above and of the following additional parts:

11. CEPH arm extension. Can be positioned both on the right or left side of the vertical column.
12. CEPH control panel. Provides an intuitive overview of the system to move the mobile column and activate the X-MIND trium medical device.
13. CEPH patient support. Allows stabilising and immobilising the patient during CEPH exams, by means of ears rest and nasion rest.
14. CEPH detector sliding group. Enables to slide the detector to follow the X-Ray beam.
15. CEPH secondary collimator. Is positioned on U-arm; it translates during X-Rays (keeping aligned the X-Ray beam emerging from the tube head with the CEPH detector).
16. CEPH detector. This flat panel detector is indicated for use in generating radiographic images of the maxillo-facial region, more specifically it is dedicated for CEPH acquisitions. It gives 2D images of the whole patient head; this detector can optionally be moved from the CEPH arm to the detector sliding group for PAN examinations.

2.4 X-MIND TRIUM CONFIGURATIONS

X-MIND trium can be sold in these configurations:

PAN only

- The equipment can carry out uniquely exams of the PAN group (PAN, TMJ, Sinus);
- The image detector is fixed to the PAN bay;
- All the exams are carried out with the same extension in height (146 mm height on image receptor), primary collimator being of fixed dimension;
- The equipment can be upgraded in a later stage by replacing and adding several parts.

PAN and CBCT

- The equipment can carry out both exams of the PAN group (PAN, TMJ, Sinus) and of the CBCT group;
- There are two image detectors, one for PAN and one for CBCT exam; the equipment automatically exposes in front of X-Ray source the right detector, depending on the selected exam;
- PAN exams can be carried out with different extension in height (up to 146 mm height on image receptor), since the collimator height can be adjusted depending on the exam selected by the user;
- CBCT exams can be carried out at different FOV dimensions as specified in the technical data appendix;
- The equipment can be upgraded in the field to CEPH configuration by simple procedure, adding CEPH arm with CEPH image detector replacing the existing PAN image detector.

PAN / CEPH

- The equipment can carry out both exams of the PAN group (PAN, TMJ, Sinus) and of the CEPH group (AP/PA, LL, carpus);
- The image detector can optionally be unique, both for PAN and CEPH exams, and in this case it must be manually moved by the operator from PAN bay to CEPH bay and viceversa, depending on the selected exam; otherwise two different detectors can be dedicated: one for CEPH exams and the other one for PAN exams;
- The exams can be carried out with different extension in height (up to 146 mm height on image receptor for PAN, up to 220 mm height on image receptor for CEPH), since the primary collimator can be automatically adjusted in height depending on exam selected by the user;
- The equipment can be upgraded in the field to CBCT configuration by a simple procedure, adding CBCT image detector and bite block holder with vertical movement.

PAN / CBCT / CEPH

- The equipment can carry out all feasible exams of the PAN group (PAN, TMJ, Sinus), of the CEPH group (AP/PA, LL, carpus) and of the CBCT group;
- There are optionally two image detectors, one for PAN/CEPH and one for CBCT exam; in this case the PAN/CEPH image detector must be manually moved by the operator from PAN bay to CEPH bay and viceversa; otherwise three image detectors, one for PAN, one for CEPH and one for CBCT exams;
- To carry out PAN or CEPH or CBCT exam the equipment automatically exposes in front of X-Ray source the right detector, depending on the selected exam;
- PAN and CEPH exams can be carried out with different extension in height (up to 146 mm height on image receptor for PAN, up to 220 mm height on image receptor for CEPH), since the primary collimator can be automatically adjusted in height depending on exam selected by the user;
- CBCT exams can be carried out at different FOV dimensions as specified in the technical data appendix.

2.5 EXAMS

In its different configurations X-MIND trium equipment carries out the following exams:

Panoramic group

The panoramic group includes all the 2D radiographs of the jaws, dentition, temporomandibular joints and maxillary sinuses.

1) Standard panoramic

- Full scan
- Right side only
- Left side only

2) Sectorial panoramic with improved orthogonality

- Full scan
- Right side only
- Left side only

3) Frontal panoramic

4) Bitewings

5) Frontal temporomandibular joint with closed or open mouth

- Both sides
- Left TMJ only
- Right TMJ only

6) Lateral temporomandibular joint with closed or open mouth

- Both sides
- Left TMJ only
- Right TMJ only

7) Frontal maxillary sinuses

8) Lateral maxillary sinuses

- Left sinus only
- Right sinus only

CBCT group

The CBCT group includes all the 3D CBCT examinations of the dental and maxillofacial regions. Here below the size of the reconstructed volumes expressed as diameter x height.

1) Dental FOV

- 40mm x 40mm
- 60mm x 60mm
- 80mm x 80mm
- 110mm x 80mm



NOTE :

A specific version of AIS software disables FOV 110mm X 80mm

2) ENT FOV – Nose

- 110mm x 80mm



NOTE :

A specific version of AIS software disables FOV 110mm X 80mm

3) ENT FOV – Ear

- Left ear only, 60mm x 60mm
- Right ear only, 60mm x 60mm

Cephalometric group

- Frontal (AP/PA)
- Lateral (LL)
- Hand acquisition (Carpus - special support needed)

For all examination groups, the operator set the predefined loading factors, in terms of X-ray anodic current and X-ray tube voltage, by selecting the patient type between the following options:

- MAN
- small

- medium
- large

- WOMAN
- small
- medium
- large

- CHILD
- small
- medium
- large

For the panoramic group and the cephalometric group, the operator can still modify the loading factors by means of dedicated sliders.

! **WARNING :**

Only physicians or dentists properly trained can modify the loading factors from the predefined values for the panoramic and cephalometric groups taking into account the effects on the image quality, increase/decrease of radiation dose and the needs of the clinical task.

On the contrary, for the CBCT group, the operator cannot modify the anodic current and tube voltage, but can just select the quality of the 3D reconstruction between three protocols:

- Standard quality
- Medium quality
- High quality

The X-ray exposure time of the scan increases from the standard quality to the high quality involving both the improvement of the image quality and the increase of the radiation dose to the patient.

! **WARNING :**

Only physicians or dentists properly trained can select the quality protocol for the CBCT groups taking into account the effects on the image quality, increase / decrease of radiation dose and the needs of the clinical task.

2.6 CONTROL PANELS

Equipment control panels are used during patient positioning phase.

Available keys allow to move the equipment to Initial position before patient access, turn on positioning LASERs, adjust the U-arm position to align the patient to X-ray beam and set the "ready to X-ray" status.

Some keys are duplicated on the CEPH control panel, for use during patient positioning for CEPH exams.

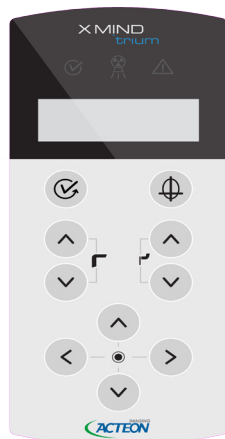

Equipment control panel

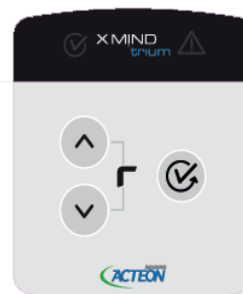

CEPH control panel

CAUTION :

Some of the keys give the operator the possibility to move parts of the equipment. When pressing them the operator must check carefully the patient and, in case of possible collision between equipment and patient, stop immediately the movement by releasing the key.

2.7 KEYS DESCRIPTION

0 position key



After setting the exam parameters from operator's workstation, by a single pressure of this key, the equipment moves to the initial position.

When the U-arm reaches its initial position, the green status indicator will blink and the patient can be placed inside the equipment.



Once the patient is correctly positioned on the equipment, a dummy run without X-Ray emission can be done by continuously pressing this key.

This key is also present on CEPH control panel and has the same functionality.

LASERs key



Turns on/off the positioning lasers.

Only when the green status indicator is blinking, by a single pressure of this key, the patient positioning lasers turn on and remain on until the key is pressed again.

Column up or down

Press the following keys:



These keys are also present on CEPH control panel and have the same functionality.

Bite block up or down

Press the following keys:



By single pressure of these keys the selected part of the equipment is moved by 1 mm.

Horizontal movements keys

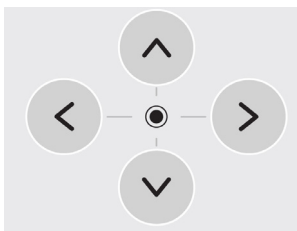

These keys move the U arm in the arrows direction, in order to place the LASER in the required position on patient face. By single pressure of one of these keys the rotating U-arm is moved by 1 mm in the arrow direction. These keys are enabled only for a sub-set of exams; for all remaining exams the pressure on these keys does not have any effect.

2.8 LIGHT INDICATORS



Green Status indicator

- Blinking. The equipment is in the initial position. Patient can be placed under the equipment and positioning LASERs can be turned ON.
 - ON. The acquisition can start.
- This indicator is also present on CEPH control panel.



Yellow X-Ray indicator

- OFF. No X-Ray emission.
- ON. X-Ray emission on going.



Red Error indicator

- ON. The equipment is in error status.

2.9 X-MIND TRIUM REMOTE CONTROL

The X-MIND trium remote control must be kept in a safe place protected against radiations, in compliance with local standards in force concerning radiation protection. The X-MIND trium remote control allows the operator to activate or deactivate X-ray emissions from the control room.

The components are listed below with a brief description of the parts.

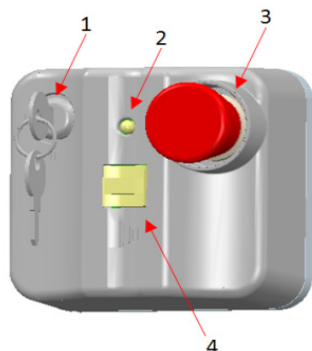

1. Safety key selector switch. Deactivates the X-ray emission switch to prevent accidental exposure.

2. X-ray emission LED. Remains on during the entire acquisition.
3. Remote emergency switch. Allows stopping the device in the event of emergency.
4. X-ray emission switch. Activates acquisition.

2.10 EMERGENCY SWITCHES

This device is equipped with two emergency switches that allow to stop the movement of parts and X-ray emission in the event of an emergency.

Patient emergency switch

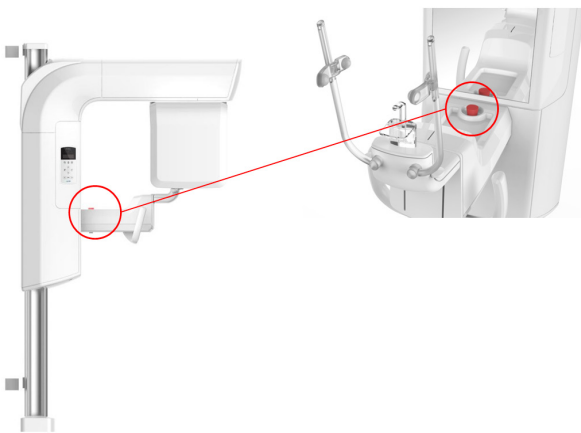

The patient emergency switch is installed on the head support and is within the patient's reach, to allow both the patient and the operator to stop the device in the event of panic or hazards, sudden column motion or any anomaly. The operator must inform and instruct the patient on the emergency procedures and on the use of the emergency switches of the device, as indicated in this chapter.

Remote emergency switch

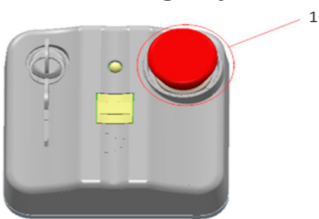

1= Remote emergency switch

The Remote emergency switch is located on the X-MIND trium remote control.

How to use the emergency switches

In case of an emergency, stop any movement of the device and X-ray emission by pressing either the patient emergency switch or the remote emergency switch. This action puts the device in the emergency status.

To reset the emergency status, first solve the emergency condition and then release the emergency switch by turning it clockwise until it reaches its initial position.

2.11 X-RAY EXPOSURE SWITCH



X-ray exposure switch

To activate the exposure, the operator must press and hold the X-ray exposure switch for the entire acquisition. Meanwhile, the yellow X-ray exposure LED stays ON to indicate X-ray emission.

If the operator removes his/her finger from the exposure button before acquisition is complete, X-ray emission and U-Arm rotation will be interrupted and the X-ray exposure LED will turn off. At this point, an error message appears in the AIS software. This message must be deleted before using the medical device again.

2.12 HEAD SUPPORT FOR PAN/CBCT EXAMS

The head support positions and immobilises the patient before the scan. It is equipped with a chin rest and forehead support to ensure maximum stability.

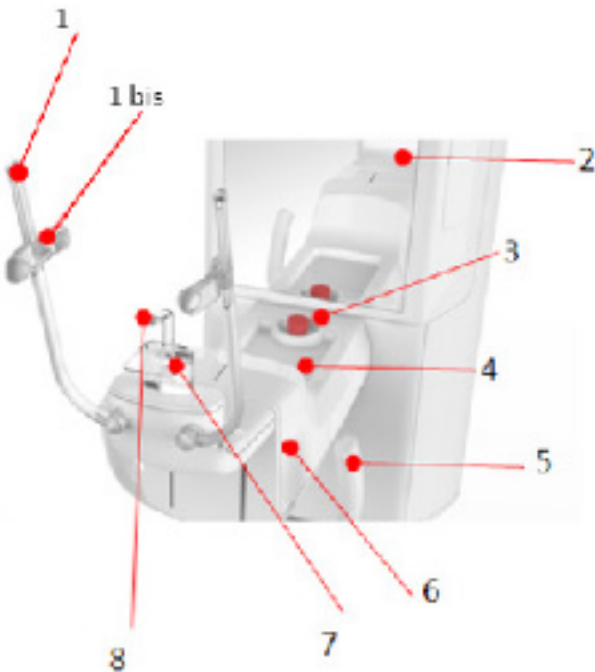

1. Temple rest
2. Patient mirror
3. Patient emergency switch
4. Courtesy tray
5. Handlebar
6. Temple knob
7. Chin rest
8. Bite block

2.13 HEAD SUPPORT FOR CEPH EXAMS

The head support in CEPH arm positions and immobilises the patient before the scan. It is equipped with a couple of ear rests and a nose support to ensure maximum stability.

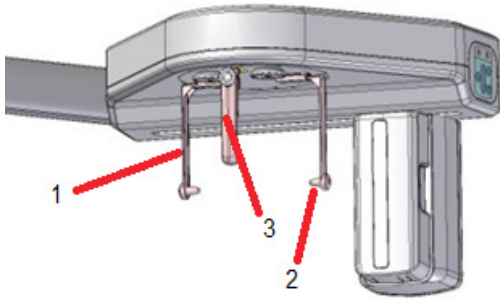

1. Ear rest
2. Ear rest knob
3. Nose support

To adapt to the patient's anatomy, the CEPH head support is equipped with:

- Ear rest knob for horizontal ear rest movement.
- Nose support, that can be manually moved in horizontal and in vertical.

2.14 ACCESSORIES

Temple rest

The temple rest supports provide support, frontal and lateral stability to the patient's head for all types of examination.

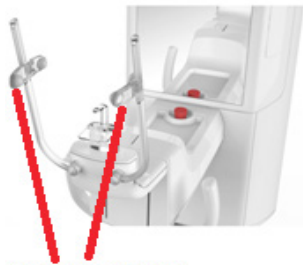

TEMPLE REST

Chin rest

The chin rest allows immobilizing the patient's mouth during the 3D CBCT and the 2D maxillary sinus exams; it should also be used for 2D panoramic exams in case of edentulous patients.



Sliding bite block and chin rest assembly

The combined use of the bite block and the chin rest improves the stability of the jaws, allows separating the teeth during the acquisition and places in the same vertical plane the superior and the inferior incisors.

The bite block and chin rest assembly must be used for immobilizing the patient in panoramic exams except in case of edentulous patients; in addition, it can be used in CBCT scans when an improved 3D reconstruction of the dental crown surface is required.

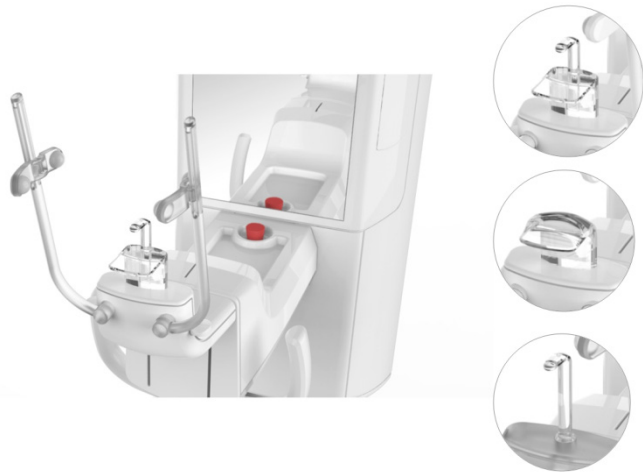

TMJ nose support

This support must be used for TMJ examinations since it is specifically designed to stabilize the patient's head in both open mouth and closed mouth conditions.

Calibration tray and geometric calibration phantom

The Calibration tray is used to position the geometric calibration phantom during the calibration procedure of the CBCT apparatus.

The calibration procedure consists of a scan of the calibration phantom and the estimation of a set of parameters that describe the configuration of the system.

Quality phantom support for Germany

This accessory is intended to position the QUART DVT test phantoms for QA/QC of CBCT functionality for X-MIND trium installed in Germany.

Self standing base

This accessory allows to install X-Mind trium where the wall cannot adequately support trium load.

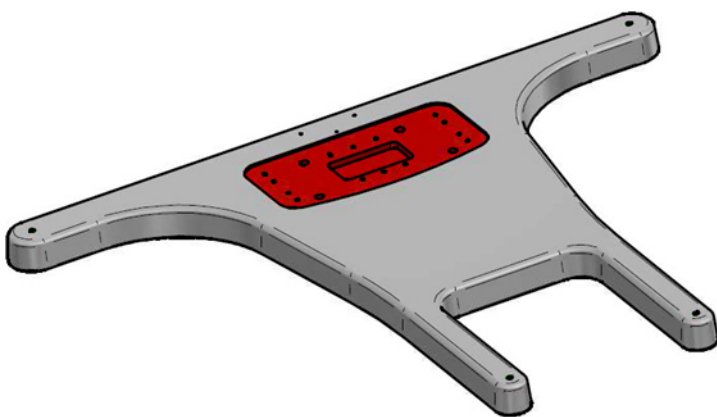

SWITCHING ON / OFF THE SYSTEM

3.1 SWITCHING ON

To turn the system ON, proceed as follows:

- Ensure that the system is properly connected to the power supply.
- Switch the medical device by setting the Main switch to ON position (I). The main switch is located below the patient support.



1 Main switch

- Switch on the workstation.
- Log into the operating system and click on the icon of the AIS software. 
- Wait for the AIS to be launched.
- Select the language among the available ones, type in the User Name and Password and press OK.
- X-MIND trium automatically loads the software and connects the workstation with the medical device.
- Check connection status between device and workstation referring to the icon shown on the display of the control panel

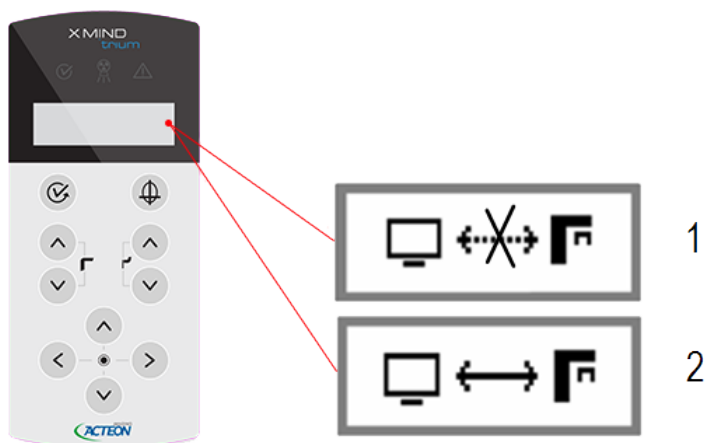

ENGLISH

Not connected



- This icon is shown during device start-up, when workstation is turned off or if there is a connection problem.

Connected

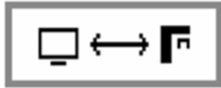

- The medical device is ready to perform acquisitions, calibrations and quality tests.

3.2 SWITCHING OFF

- To turn the system off, proceed as follows:

- Press the EXIT  button in the MENU BAR of the AIS software.

- Turn the X-MIND trium workstation off.

- Switch OFF the medical device by setting the main switch to off. The main switch is located on the lower part of the patient support.



CAUTION :

Always switch the system off during long period of inactivity like night time, weekends and holidays.

PRE ACQUISITION

This chapter describes the procedure to acquire images of a new patient using X-MIND trium. The instructions below describe how to prepare the system, position the patient and scan the anatomical volume.

4.1 PREPARING THE SYSTEM

- Upon starting the system, wait at least 5 minutes before carrying out an acquisition, calibration or quality test. Failure to comply with this provision can cause noise and defects in the acquired images.
- Ensure that all components are operating and that there are no error messages or notifications.
- Ensure that the medical device is properly calibrated.

4.2 CREATING OR SELECTING PATIENT DATA

Patient data must be created or selected from patient database. To do so, follow the procedure described in the manual of Acteon imaging suite software.

- Select the exam

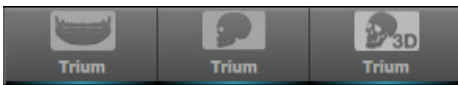

4.3 INSTRUCTING THE PATIENT

- Describe the functions of the device to the patient, position the patient, and provide all the safety instructions.
- Use the demo function to show the patient how the U-Arm rotates (PAN/CBCT exams) or detector translates (CEPH image) during the scan.
- To start this function, press and keep pressed the "0 Position" key on the control panel.



CAUTION :

Never position the patient or have the patient inside the machine during the «0 position» phase!

- To stop the demo movement, release "0 Position" key. Press the button again to bring the U-Arm back to its initial position.
- Explain in detail the use of the local emergency switch.
- Ask the patient to remove any metal object or jewel from his / her head, neck or mouth (earrings, necklaces, partial dentures, hairclips).
- Pay special attention in the cases of children, disabled people, seniors and obese persons.
- Instruct patients on how to control their breathing during the scan. Breathing should be slow and low to minimise patient movements.
- Complete all the preliminary steps before positioning the patient to minimise the time to perform the examination and prevent delays.

4.4 POSITIONING THE PATIENT FOR PAN/CBCT EXAMS

This section describes the procedure to place the patient on the device and to carry out all panoramic and CBCT scan.

- Install the patient support best suited to the examination to be carried out, as described in the table here below:

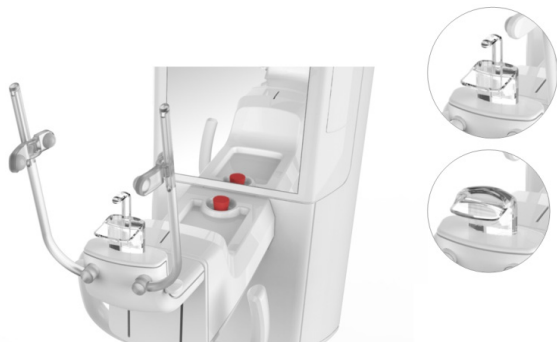

Support	Examination	Specific note
Temple rest	<ul style="list-style-type: none"> • All exams 	
Chin rest	<ul style="list-style-type: none"> • All exams of the CBCT group • Frontal and lateral maxillary sinuses • Standard panoramic, orthogonal panoramic, bitewings and frontal panoramic, only in case of edentulous patients 	Suitable for edentulous patients
Sliding bite block and chin rest assembly	<ul style="list-style-type: none"> • All exams of CBCT group, if 3D reconstruction of crowns of teeth is required • Standard panoramic, orthogonal panoramic, bitewings and frontal panoramic 	Unsuitable for edentulous patients
TMJ nose support	<ul style="list-style-type: none"> • Frontal and lateral TMJ with open or close mouth 	Suitable for edentulous patients

- Apply the disposable protection devices (class I Medical Device Directive 93/42/EEC and subsequent amendments) to the parts that come into contact with the patient: chin rest, temple rest, bite block and handlebar.

CAUTION :

The bite covers can cause dangerous injuries (even death) if swallowed.

Please use the disposable protections as recommended by the manufacturers in the instructions for use; make sure the disposable protections are fixed on their support and cannot move in the mouth or in the throat of the patient.

- Use the COLUMN UP and DOWN buttons to adjust the height of the mobile column and adapt the head support to the patient's stance (sitting or standing).



ENGLISH

- Ask the patient to approach the head support and hold of the handlebar. Ask the patient to have a natural posture and relax.
- Ask the patient to firmly grasp the handgrip with both hands.
- If the patient is fitted with a lead-lined apron for radiation protection, make sure that his neck is not covered, because this will cause unexposed areas in the radiograph.

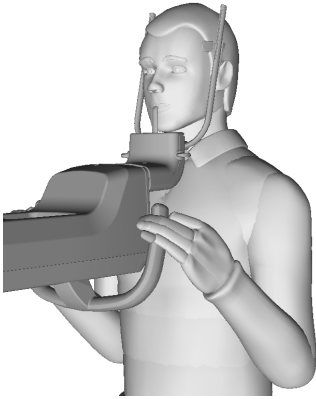

The X-MIND trium is equipped with five laser beams that help the operator position the patient in the FOV.

- Ask the patient to close his/her eyes.
- When the patient's eyes are closed, turn the lasers on by pressing the PATIENT POSITIONING LASER button on the control panel. The positioning lasers will light up.

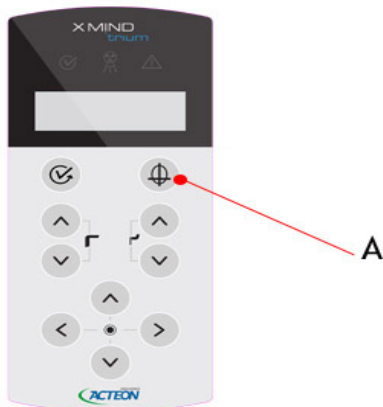

A = Patient positioning laser button.

For details about the use of the lasers, refer to paragraphs 5.2 (for PAN exams) and 6.2 (for CBCT exams).

ENGLISH

5

PAN ACQUISITION

5.1 SELECTING THE EXAM TYPE

· From the AIS tool bar press the PAN button to enter in the acquisition window.

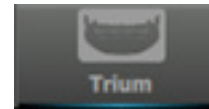

· From the acquisition window (refer to AIS Operator's manual for the description of the acquisition window) select the patient's type (man, woman, child) and size (small, medium, large).

· Select the type of exam and check the predefined loading factors.

· Press the "0 position" button.

· The green status indicator will start blinking and the U-arm will reach the reset position.

Table of loading factors

if in service software the flag "US" is enabled « **flag - MANDATORY for US market** » the values of loading factors for each type of exam and for each patient size are indicated below.

They constitute recommendations to be applied directly to optimize operation

	Child medium		Woman small		Man small		Woman medium		Man medium		Woman large		Man large	
	kV	mA	kV	mA	kV	mA	kV	mA	kV	mA	kV	mA	kV	mA
PANORAMIC	68	7	72	7	73	7	75	7	76	7	78	7	79	7
TMJ	63	6	69	6	70	6	72	6	73	6	75	6	76	6
SINUS	68	7	72	7	73	7	75	7	76	7	78	7	79	7

otherwise, if in service software the flag "US" is not enabled

The values of loading factors are indicated below :

	Child medium		Woman small		Man small		Woman medium		Man medium		Woman large		Man large	
	kV	mA	kV	mA	kV	mA	kV	mA	kV	mA	kV	mA	kV	mA
PANORAMIC	66	8	72	8	73	8	75	8	76	8	78	8	79	8
TMJ	63	6	69	6	70	6	72	6	73	6	75	6	76	6
SINUS	66	8	72	8	73	8	75	8	76	8	78	8	79	8

5.2 PATIENT POSITIONING

- Patient's feet should be moved forward and brought together, so that the patient's body is straight and slanted, he/she should slightly hang from the handgrip (compatible with his/her physical possibility to maintain this uncomfortable position during the examination). The purpose of this position is to stretch the spine as much as possible, in order to decrease the artefact shadow that would be cast into the image.

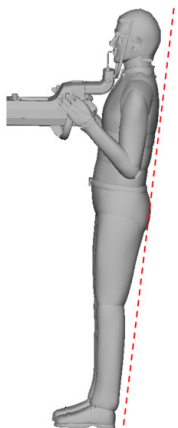

- The picture below shows the proper placement of the feet or the wheelchair respect to the base for devices installed with the accessory "Self-standing base".

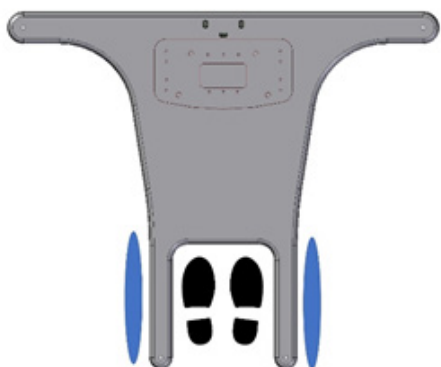

In any case, the patient may also stand in natural and more comfortable position if he/she cannot hold the above described position (e.g. elderly people). Patients in wheelchairs can also be positioned.

- Ask the patient to remove glasses, necklaces, earrings, piercing, etc. before positioning him/her and carry out the scan
- Ask the patient to bite the bite block (or place chin on the chin rest for edentulous patients).

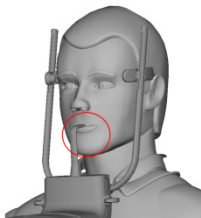

- Turn on positioning LASERS.



X-MIND trium is a **class 3R laser** product. Avoid direct eye exposure to laser radiation. Viewing the laser output with telescopic optical instruments (for example, telescopes and binoculars) may pose an eye hazard and thus the user should not direct the beam into an area where such instruments are likely to be used

Use of controls or adjustments or performance of procedures other than those specified herein may result in hazardous radiation exposure

ENGLISH

- Close temple rest on the patient forehead and, gently move patients head to the correct position with his mid-sagittal plane corresponding to the mid-sagittal LASER.

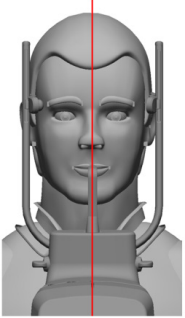

- Move slightly up or down the equipment until Frankfurt laser is centered on Frankfurt plane of the patient. This laser is composed by five lines. Refer to one of these lines to position the patient. Be sure that this line (and consequently patient's Frankfurt plane) is horizontal and parallel to the floor.

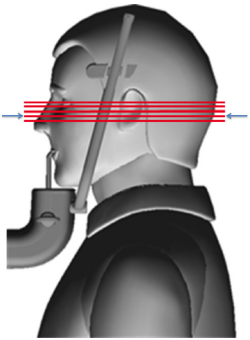

- If it is necessary, adjust the machine in order to centre the canine laser plane on the patient canine for PAN and SINUS exams and on temporo-mandibular joint for TMJ exams. Move the U-arm by pressing the dedicated keys to adjust the anterior or posterior directions.

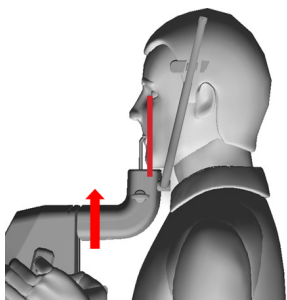

for PANORAMIC and SINUS exams

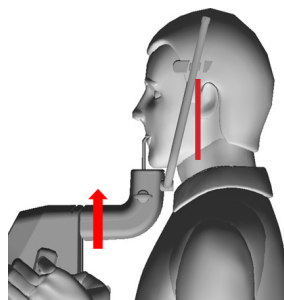

for TMJ exams

- After that the patient is properly positioned on the chin rest or bite support, adjust the temple rest support by means of the temple rest knobs.
- Ensure that the patient is positioned in such a way that no part of the body can come into contact with or collide against the mobile column or the U-Arm or the CEPH arm during the scan.
- Ensure that hair and clothes do not remain caught in the mobile column or in the U-Arm.
- Ask the patient to keep tongue raised on the palate.
- Ask the patient to keep still during U-arm rotation or any mechanical motion of the device.

5.3 EXECUTION OF THE PAN EXAM

- Once the patient is correctly positioned, press “O position” button; the green status indicator will be ON.
- Ask the patient to press his/her tongue to the palate.
- Ask the patient to stay still during the whole exposure.
- Go out from the room to start exam; do not forget to observe the applicable radiation safety procedure.
- Start the PAN exam by pressing the X-ray emission switch on the X-MIND trium remote control. During this stage, the device emits X-rays; the X-ray emission LED on the control panel and the X-ray exposure LED on the X-MIND trium remote control will light up.

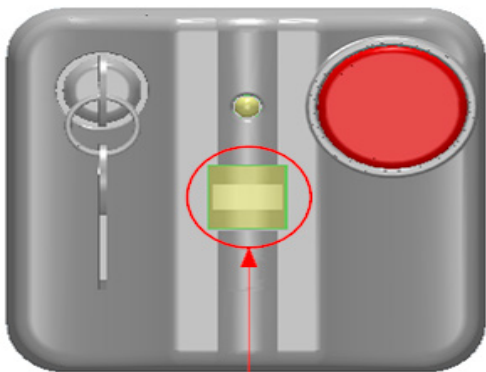

A



B

A = X-ray emission switch

B = X-ray emission LED

- Keep the switch pressed for the whole duration of the exam until the U-arm stops. If the switch is released earlier, the X-ray emission and the carriage movements will be stopped and the exam is irretrievably interrupted (“dead man” exposure mode); in this case, the device must be reset and the patient positioning redone.

CAUTION :

Monitor the patient throughout the entire exposure. In the event of an emergency, release the X-ray exposure switch to stop the U-arm rotation and X-ray emission.

In the event that the U-arm rotation and/or X-ray emission do not stop, press the remote emergency switch.

6

CBCT ACQUISITION

6.1 SELECTING THE EXAM TYPE

· From the AIS tool bar press the CBCT button to enter in the acquisition window.

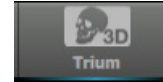

· From the acquisition window (refer to AIS Operator's manual for the description of the acquisition window) select the patient type (man, woman, child) and size (small, medium, large).

· Select the sector of the exam (dental, nose, ear), the dimension of the FOV and the quality of the image, then check the predefined loading factors.

FOV selection

The size of the FOV describes the scan volume of CBCT exam. That volume determines the extent of anatomy included.

CAUTION

To the extent practical, FOV should only slightly exceed the dimensions of the anatomy of interest.

For most endodontic applications limited FOV CBCT is preferred to medium or large FOV CBCT because there is less radiation dose to the patient, higher spatial resolution and shorter volumes to be interpreted.

FOV (mm X mm)	Interested area	Clinic indications	Technical data	
40 x 40	Partial dental arch	This examination is suitable for investigating localised dental problems and planning single implants.	Nominal FOV:	cylindrical, 40 mm x 40 mm (diameter x height)
			Resolution:	standard medium, high,
			Reconstruction grid (default):	400x400x400
			Voxel size (default):	0.1 mm

ENGLISH

FOV (mm X mm)	Interested area	Clinic indications	Technical data	
60 x 60	Half dental arch	This examination is suitable for investigating localised dental problems and planning single implants.	Nominal FOV:	cylindrical, 60 mm x 60 mm (diameter x height)
			Resolution:	low, medium, high, custom
	Ear	This examination is useful for diagnostic investigations of the auditory system.	Reconstruction grid (default):	600x600x600
			Voxel size (default):	0.1 mm

FOV (mm X mm)	Interested area	Clinic indications	Technical data	
80 x 80	Dental arch	The dental arch examination allows viewing the entire oral region, including the mental and mandibular foramen.	Nominal FOV:	cylindrical, 80 mm x 80 mm (diameter x height)
			Resolution:	low, medium, high, custom
			Reconstruction grid (default):	500x500x500
			Voxel size (default):	0.15 mm

FOV (mm X mm)	Interested area	Clinic indications	Technical data	
110 x 80  NOTE : A specific version of AIS software disables FOV 110mm X 80mm	Full dental arch	The full dental arch examination shows the entire dental region, mandibular anatomy, lower paranasal sinuses, TMJ and airways. The software uses the volumetric data to reconstruct a virtual dental panoramic view. This digital panoramic projection is of higher quality than conventional ones, thanks to the absence of geometric distortions and reduction of partial volume effects.	Nominal FOV:	cylindrical, 110 mm x 80 mm (diameter x height)
			Resolution:	low, medium, high, custom
	Nose	This examination is used for diagnostic investigations of upper airways and paranasal sinuses.	Reconstruction grid (default):	693x693x500
			Voxel size (default):	0.15 mm

ENGLISH

RESOLUTION selection

Set high resolution (High Quality) to improve the diagnostic accuracy of endodontic-specific tasks such as the visualization of small features including calcified/accessory canals, missed canals, disruptions in the periodontal ligament space, small alterations, etc.

If the Standard or Medium protocol can be used for a diagnostic task that requires lower resolution, it should be employed, absent strong indications to the contrary.

CAUTION

For choice of resolution take also in account the increase of dose of Medium and High quality with respect to Standard: refer to section 11.15.2 for dosimetric indications (CTDI for CBCT EXAMS)

· Press the "0 position" button.

-The green status indicator will start blinking and the U-arm will reach the reset position.

Table of loading factors

The values of loading factors indicated below for each patient size are predefined; they constitute recommendations to be applied directly to optimize operation.

	Child medium		Woman small		Man small		Woman medium		Man medium		Woman large		Man large	
	kV	mA	kV	mA	kV	mA	kV	mA	kV	mA	kV	mA	kV	mA
CBCT	80	8	85	6	90	6	85	8	90	8	85	10	90	10

CAUTION :

The TYPE OF EXAM SECTION controls the collimation openings to obtain the required FOV.

Bear in mind that a broader FOV is obtained by a wider X-ray beam which encloses a larger anatomical region but also implies an increase in radiation dose absorbed by the patient.

6.2 PATIENT POSITIONING

	<p>X-MIND trium is a class 3R laser product. Avoid direct eye exposure to laser radiation. Viewing the laser output with telescopic optical instruments (for example, telescopes and binoculars) may pose an eye hazard and thus the user should not direct the beam into an area where such instruments are likely to be used</p>
<p>Use of controls or adjustments or performance of procedures other than those specified herein may result in hazardous radiation exposure</p>	

- The mid-sagittal plane laser (A) is located on the U-arm and identifies the sagittal plane. It is used to position the patient symmetrically with respect to the rotation axis of the scanning apparatus.
- The Axial plane laser (B) is located on the X-ray tube and identifies the bottom limit of the X-ray beam, that is the bottom limit of the acquired volume.
- The coronal plane laser (C) identifies the coronal plane and is also located on the X-ray tube.

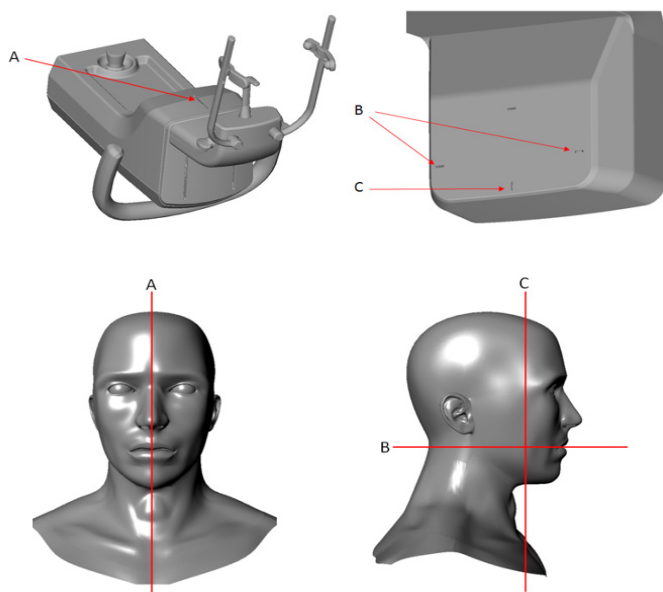

The intersection between the mid-sagittal plane laser and the coronal plane laser represents the Axis of Rotation (AOR) of the scanning apparatus, that is the central axis of the acquired volume.

Once the patient is positioned correctly with respect to the lasers, adjust the chin rest support by means of the control panel commands in order to reach the correct position.

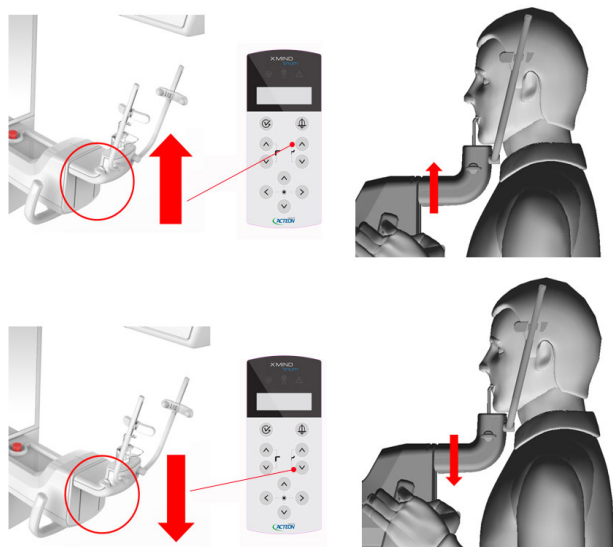

Close temple rest on the patient forehead and gently move the patient's head to the correct position with his/her mid-sagittal plane corresponding to the mid-sagittal LASER.

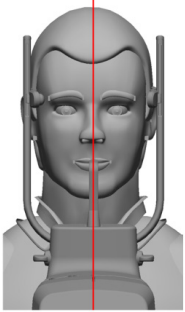

6.3 EXECUTION OF THE CBCT EXAM

- Once the patient is correctly positioned, press "O position" key.



- The green status indicator will be ON and the U-arm will reach the start position.



- Ask the patient to stay still during the whole exposure.
- Go out from the room to start exam; do not forget to observe the applicable radiation safety procedure.
- Start the CBCT scan or acquire a scout view of the patient by pressing the X-ray emission switch on the X-MIND trium remote control. During this stage, the device emits X-rays; the X-ray emission LED on the control panel and the X-ray exposure LED on the X-MIND trium remote control will light up.

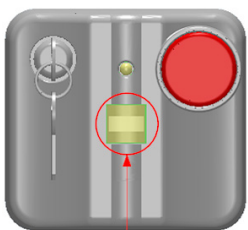

A



B

A = X-ray emission switch
B = X-ray emission LED

ENGLISH

- In case of CBCT scan, keep the switch pressed for the whole duration of the exam until the U-arm stops. If the switch is released earlier, the X-ray emission and the carriage movements will be stopped and the exam is irremediably interrupted ("dead man" exposure mode); in this case, the device must be reset and the patient positioning redone.
- In case the scout view has been selected, evaluate the scout view to establish whether the patient is positioned correctly.
- If the patient is positioned correctly, press YES to continue with the acquisition, otherwise, press NO to repeat the patient positioning procedure.

 **CAUTION :**

Monitor the patient throughout the entire exposure. In the event of an emergency, release the X-ray exposure switch to stop the U-Arm rotation and X-ray emission.

In the event that the U-Arm rotation and/or X-ray emission do not stop, press the remote emergency switch.

CEPH ACQUISITION

7.1 SELECTING THE EXAM TYPE

· From the AIS tool bar press the CEPH button to enter in the acquisition window.

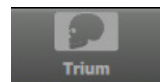

- From the acquisition window (refer to AIS Operator's manual for the description of the acquisition window) select the patient type (man, woman, child) and size (small, medium, large).
- Select the type of CEPH exam (LL, AP/PA, Carpus) and check the predefined loading factors.
- Press the "0 position" button.
- The green status indicator will start blinking and the CEPH detector sliding group will reach the reset position.

Table of loading factors

if in service software the flag "US" is enabled « **flag – MANDATORY for US market** » the values of loading factors for each type of exam and for each patient size are indicated below.

They constitute recommendations to be applied directly to optimize operation

	Child medium		Woman small		Man small		Woman medium		Man medium		Woman large		Man large	
	kV	mA	kV	mA	kV	mA	kV	mA	kV	mA	kV	mA	kV	mA
CEPH AP/PA	68	6	72	6	73	6	75	6	76	6	77	6	78	6
CEPH LL	68	8	72	8	73	8	75	8	76	8	77	8	78	8
CARPUS	66	9	72	9	73	9	75	9	76	9	77	9	78	9

otherwise, if in service software the flag "US" is not enabled

The values of loading factors are indicated below :

	Child medium		Woman small		Man small		Woman medium		Man medium		Woman large		Man large	
	kV	mA	kV	mA	kV	mA	kV	mA	kV	mA	kV	mA	kV	mA
CEPH AP/PA	72	9	76	9	77	9	79	9	80	9	82	9	83	9
CEPH LL	71	8	75	8	76	8	78	8	79	8	81	8	82	8
CARPUS	66	9	72	9	73	9	75	9	76	9	78	9	79	9

7.2 PATIENT POSITIONING

Bring the patient to the equipment, in front of CEPH patient support:

- Turn manually the whole head support to one of the three allowed positions, depending on the selected exam: AP, PA, carpus or LL.
- Set equipment height until ear rests are at the patient ears' height.
- Open horizontally the ear rests acting on the dedicated rests knobs.
- Turn in horizontal position the nose support.
- Ask the patient to slowly place himself/herself between the ear rests.
- Close the ear rests on the patient ears and gently move the patient's head to the correct position with his mid-sagittal plane corresponding to the vertical axis.
- Turn nose support in vertical position and move it vertically and horizontally until the extreme side of the support is on the nose root;

ENGLISH

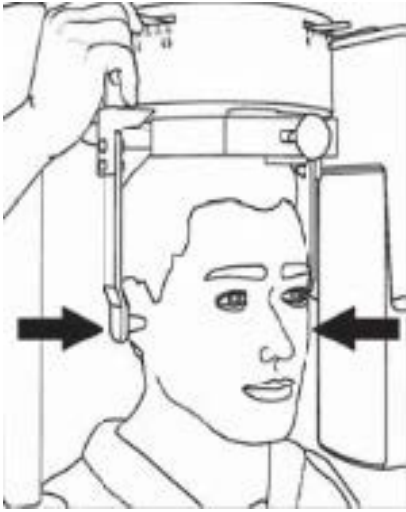

For CARPUS exam only, follow the next instructions:

+ Place the dedicated carpus support **(a)** on the CEPH patient support, lifting it with the aid of the two pins **(p)**, then fixing it with the screw **(s1)**.

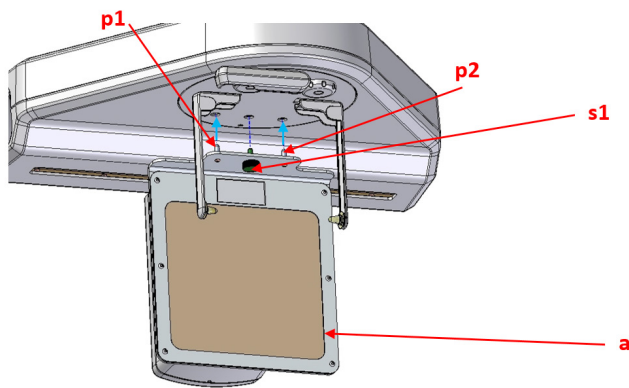

+ Open horizontally the ear rests to their maximum aperture **(b)**.

+ Turn in horizontal position the nose support **(c)**.

+ Ask the patient to place its hand on the carpus support, verifying that it is completely included in the rectangular area drawn on the support **(a)**.

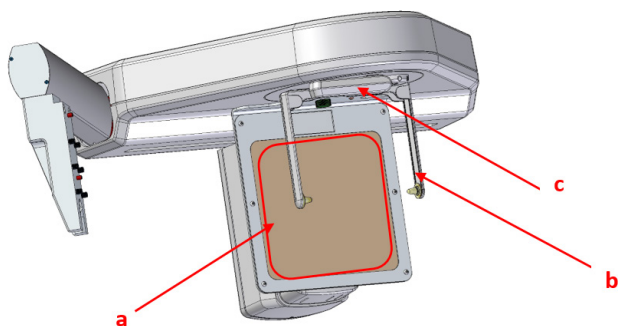

Proceed with the execution of the exam.

7.3 EXECUTION OF THE CEPH EXAM

- Once the patient is correctly positioned, press “O position button” exam button.



- The green status indicator will be ON and the U-arm will reach the start position.



- Ask the patient to stay still during the whole exposure.
- Go out from the room to start exam; do not forget to observe the applicable radiation safety procedure.
- Start the CEPH exam by pressing the X-ray emission switch on the X-MIND trium remote control. During this stage, the device emits X-rays; the X-ray emission LED on the control panel and the X-ray exposure LED on the X-MIND trium remote control will light up.

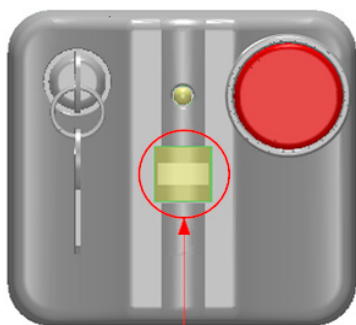

A



B

A = X-ray emission switch
B = X-ray emission LED

- Keep the switch pressed for the whole duration of the exam until the CEPH detector sliding group stops. If the switch is released early, the X-ray emission and the carriage movements will be stopped and the exam is irremediably interrupted (“dead man” exposure mode); in this case, the device must be reset and the patient positioning redone.

CAUTION :

Monitor the patient throughout the entire exposure. In the event of emergency, release the X-ray exposure switch to stop the CEPH detector sliding group shift and X-ray emission.
In the event that the sliding group shifts and/or X-ray emission doesn't stop, press the remote emergency switch.

8

RELEASING THE PATIENT

- Go inside the radiologic room, open temple rest or the ear rests and ask patient to move carefully from the equipment.
- Image will be available on the PC connected to Trium.
- After exposure the device will start a cooling down period as indicated on the control panel display.



In case of an error, a code will be shown on the display, and a red light turns on warning the operator about malfunctioning. For error details please refer to the "TROUBLESHOOTING" chapter.

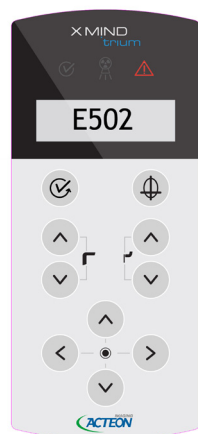

MAINTENANCE, CLEANING AND DISPOSAL

9.1 MAINTENANCE

Periodic verification of the emergency switches.

To ensure the safety of patients and operators, verify the proper operation of the remote emergency switch and local emergency switch on a monthly basis.

To verify the proper operation of remote and local emergency switches, proceed as follows:

- Turn the device on and make sure that it is operating correctly.
- Click on the U-arm rotation button on the control panel to start a reset to 0 position of the U-arm.



- Whilst the U-Arm is in motion, press the local emergency switch; the U-Arm should immediately stop as a proof of the proper operation of the emergency switch.
- Reset the emergency status by turning the local emergency switch clockwise and bringing it back to its initial position.
- Repeat the same procedure for the remote emergency switch.

CAUTION :

If an emergency switch does not work properly, contact the technical support service.

Calibration and quality control

Calibration and quality tests verify the operation and performance of the device; these tests must be carried out together with the inspection of the safety devices at least once every 6 months, unless otherwise specified in the frequency table of the installation and maintenance manual.

For other details of maintenance operations, refer to the installation and maintenance manuals.

The manufacturer shall not be held liable for damage or injuries caused by failure to carry out inspections and tests and by incomplete maintenance.

Repairs and replacements of any component must be carried out solely by authorized and highly qualified personnel and only using genuine spare parts supplied by de Götzen® S.r.l. - ACTEON Group.

9.2 CLEANING

Clean the external surface using a damp cloth with non-corrosive and non oil-based detergent; disinfect the external surface using a non-aggressive medical detergent. Do not spray any detergent or disinfectant directly on the device.

9.3 DISPOSAL

The WEEE symbol indicates that, at the end of its lifespan, the product must be disposed of separately from other waste, in compliance with Directive WEEE 2012/19 EU.

Refer to the implementation standards in your country. EU Council Directive WEEE 2012/19 EU defines a common approach intended to avoid, prevent or reduce harmful effects due to the exposure to environmental noise and to the disposal of electric and electronic equipment. This product is marked with the symbol shown above. This product must not be disposed of together with domestic waste. It must be taken to a special waste collection centre to be recovered and recycled. The crossed-out wheellie bin identifies a product placed on the market after the 13th of August 2005 (see EN 50419:2006). This product is subjected to Council Directive WEEE 2012/19 EU and national implementation standards. Refer to your supplier for the disposal of this product.

Proper disposal of this product will help protect the environment.

For further details on the disposal of this product, please contact local authorities, the provider of the domestic waste disposal service or the dealer where you have purchased it.

TROUBLESHOOTING

10.1 ERROR CODES AND REQUIRED ACTIONS

The following table describes the meaning of the various error codes:

CODE	DESCRIPTION	MEANING
A	Serious error	Serious error and reduced functionality. The detected fault is too serious for automatic restoration. The results of the operation are not valid.
B	Error	Serious fault and reduced functionality but automatic restoration procedures can be applied to continue processing. The results of the operation may not be valid. The function may only be partly completed.
C	Anomaly	Something is not working, reduced functionality.
D	Warning	Something may have gone wrong. Indicates a potential error; functionality is not reduced.
E	Information	Simple warning; functionality is not reduced. No error has been detected and no response is required. This message can indicate that a function is in progress or that an operation has been completed successfully.

The following table shows the required actions to solve the problem and the corresponding codes:

CODE	PERSON IN CHARGE OF THE SOLUTION	ACTIONS
A	X-MIND trium	Automatic reset
U	Operator	The operator can solve the problem (or reset the device)
R	Remote assistant	The problem can be solved by means of remote control
T	Technician	A repair by a technician or at the factory is required

Automatic reset

Verify the cause based on the displayed message and reset by clicking on "OK".

Manual reset

Access the Maintenance and Monitor section from the AIS and press the Reset All Alarms button.

Contact the technical assistance centre if the problem persists after manual reset.

General reset

Manually reset the device; if the error persists, turn the X-MIND trium off from the main switch and turn it on again after 30 seconds. If the error still persists leaving X-MIND trium on, restart the AIS; if the problem is still not solved, restart the Workstation. If the problem is not solved despite the general reset, contact the technical assistance centre.

Reset FPD

Access the Maintenance and Detector section from AIS and click on "close link" first and then on "open link". If the error persists, restart the AIS. Contact the technical assistance centre if the problem persists after FPD reset.

NOTE

If technical service is required please take note of: Date, hour the patient name and the error code before calling.

ENGLISH

10.2 TRIUM ERRORS

CODE	Ser	Message / Description	Act	Solution
0	C	CHECK INTERNAL ETHERNET Hw error: Main board and ETHERNET switch do not communicate In this condition X-MIND trium and workstation cannot communicate; THIS ERROR APPEARS ONLY ON THE X-MIND trium DISPLAY.	U/T	Reset error from AIS software on workstation; if error remains restart X-MIND trium and workstation; If error remains technical service is required.
13	C	Image detector not grabbing	U/T	Reset error from AIS software on workstation; if error remains restart X-MIND trium and workstation; if error remains, in case of CEPH or PAN detector, detach it from the equipment and attach it again, ascertaining to lock it correctly; if error remains technical service is required.
66	E	"CONFIG_INFO_UPDATED Configuration data have been updated"	U/T	Restart X-MIND trium and workstation in order that modifications will be effective.
67	D	"MOTOR_AXES_DO_BREAK WARNING: operator has intentionally stopped a movement releasing XRay button"	U	Wait that the full exam procedure is completed before releasing X-ray button: on the workstation will appear the message "exposure button can be released".
68	B	"MOTOR_AXES_CNTL_FSM Unexpected motors FSM condition"	A	Reset error from AIS software on workstation; if error remains restart X-MIND trium and workstation.
69	C	"MOTOR_AXES_TRJ_LOAD Trajectory loading from PC is failed"	A	Reset error from AIS software on workstation; if error remains restart X-MIND trium and workstation.
70	C	"XRAYS_DISA_ETH_LINK Xrays disabled due to ETH connection failure"	U/T	Reset error from AIS software on workstation; if error remains restart X-MIND trium and workstation; If error remains technical service is required.
71	C	"XRAYS_DISA_PC_ALARM Xrays disabled due an alarm issued from PC"	U/T	Reset error from AIS software on workstation; if error remains restart X-MIND trium and workstation; If error remains technical service is required.
72	C	"PCDRV_COMM_WDOG_ERR PC communication timeout"	U/T	Reset error from AIS software on workstation; if error remains restart X-MIND trium and workstation; Try to disable anti-virus and firewall If error remains technical service is required.
73	B	"X_AXIS_ERR_RES_RAMP Unexpected FSM condition during X-axis reset"	A	Reset error from AIS software on workstation; if error remains restart X-MIND trium and workstation;
74	C	"X_AXIS_ERR_RES_TOUT X-axis reset timeout (Uarm movement parallel to the wall)"	U/T	Reset error from AIS software on workstation; if error remains restart X-MIND trium and workstation; If error remains technical service is required.
75	B	"Y_AXIS_ERR_RES_RAMP Unexpected FSM condition during Y-axis reset"	A	Reset error from AIS software on workstation; if error remains restart X-MIND trium and workstation;

ENGLISH

76	C	"Y_AXIS_ERR_RES_TOUT Y-axis reset timeout (Uarm movement perpendicular to the wall)"	U/T	Reset error from AIS software on workstation; if error remains restart X-MIND trium and workstation; If error remains technical service is required.
77	B	"R_AXIS_ERR_RES_RAMP Unexpected FSM condition during R-axis reset"	A	Reset error from AIS software on workstation; if error remains restart X-MIND trium and workstation;
78	C	"R_AXIS_ERR_RES_TOUT R-axis reset timeout (Uarm rotation)"	U/T	Reset error from AIS software on workstation; if error remains restart X-MIND trium and workstation; If error remains technical service is required.
79	B	"C_AXIS_ERR_RES_RAMP Unexpected FSM condition during B-axis reset"	A	Reset error from AIS software on workstation; if error remains restart X-MIND trium and workstation;
80	C	"C_AXIS_ERR_RES_TOUT C-axis reset timeout (CEPH image detector slider)"	U/T	Reset error from AIS software on workstation; if error remains restart X-MIND trium and workstation; If error remains technical service is required.
81	B	"S_AXIS_ERR_RES_RAMP Unexpected FSM condition during S-axis reset"	A	Reset error from AIS software on workstation; if error remains restart X-MIND trium and workstation;
82	C	"S_AXIS_ERR_RES_TOUT S-axis reset timeout (image detectors slider on Uarm)"	U/T	Reset error from AIS software on workstation; if error remains restart X-MIND trium and workstation; If error remains technical service is required.
83	B	"B_AXIS_ERR_RES_RAMP Unexpected FSM condition during B-axis reset"	A	Reset error from AIS software on workstation; if error remains restart X-MIND trium and workstation;
84	C	"B_AXIS_ERR_RES_TOUT B-axis reset timeout (bite block vertical movement)"	U/T	Reset error from AIS software on workstation; if error remains restart X-MIND trium and workstation; If error remains technical service is required.
85	C	"R_AXIS_ERR_POT_BLK R-axis potentiometer (Uarm) blocked (readings not coherent with movement)"	U/T	Reset error from AIS software on workstation; if error remains restart X-MIND trium and workstation; If error remains technical service is required.
86	B	"R_AXIS_ERR_POT_RAMP Unexpected FSM condition during R-axis reset positioning based on potentiometer value"	A	Reset error from AIS software on workstation; if error remains restart X-MIND trium and workstation;
87	B	"R_AXIS_ENC_HW_FATAL Hardware error on R-axis encoder"	T	Reset error from AIS software on workstation; if error remains restart X-MIND trium and workstation; If error remains technical service is required.
88	C	"R_AXIS_ENC_CNT_ZERO Zero-search for R-axis encoder is failed"	T	Reset error from AIS software on workstation; if error remains restart X-MIND trium and workstation; If error remains technical service is required.
89	B	"X_AXIS_ERR_RUN_PTPT Unexpected FSM condition during X-axis position adjustment"	A	Reset error from AIS software on workstation; if error remains restart X-MIND trium and workstation;
90	B	"Y_AXIS_ERR_RUN_PTPT Unexpected FSM condition during Y-axis position adjustment"	A	Reset error from AIS software on workstation; if error remains restart X-MIND trium and workstation;
91	B	"B_AXIS_ERR_RUN_PTPT Unexpected FSM condition during B-axis position adjustment"	A	Reset error from AIS software on workstation; if error remains restart X-MIND trium and workstation;

ENGLISH

92	C	"R_AXIS_ERR_RUN_LIMI R-axis position out of range"	A	Reset error from AIS software on workstation; if error remains restart X-MIND trium and workstation;
93	C	"HI_VOLT_ENA_IN_IDLE XRay button activated when not allowed"	U/T	Reset error from AIS software on workstation; if error remains restart X-MIND trium and workstation; If error remains technical service is required. (Probably, someone pushed exposure button accidentally)
94	C	"INVERTER_LINK_ERROR CAN communication error between Mainboard and Inverter"	T	Reset error from AIS software on workstation; if error remains restart X-MIND trium and workstation; If error remains technical service is required.
95	B	"FW_UPDATED_CANT_EXE Cannot exec firmware after update (board need hardware reset)"	T	Reset error from AIS software on workstation; if error remains restart X-MIND trium and workstation;
96	C	"EEPROM_DEVICE_ERROR Inverter board error: GENERAL STATE ERROR, bit 0 - EEPROM"	T	Reset error from AIS software on workstation; if error remains restart X-MIND trium and workstation; If error remains technical service is required.
97	C	"EEPROM_DMA_RD_ERROR Inverter board error: GENERAL STATE ERROR, bit 1 - EEPROM READ DMA FAILURE"	T	Reset error from AIS software on workstation; if error remains restart X-MIND trium and workstation; If error remains technical service is required.
98	C	"EEPROM_DMA_WR_ERROR Inverter board error: GENERAL STATE ERROR, bit 2 - EEPROM WRITE DMA FAILURE"	T	Reset error from AIS software on workstation; if error remains restart X-MIND trium and workstation; If error remains technical service is required.
99	C	"EEPROM_I2CBUS_ERROR Inverter board error: GENERAL STATE ERROR, bit 3 - EEPROM I2CBUS"	T	Reset error from AIS software on workstation; if error remains restart X-MIND trium and workstation; If error remains technical service is required.
100	C	"ANOD_CURR_NOT_CALIB Inverter board error: GENERAL STATE ERROR, bit 4 - ANODIC CURRENT NOT CALIBRATED"	T	Reset error from AIS software on workstation; if error remains restart X-MIND trium and workstation; If error remains technical service is required.
101	C	"HI_VOLT_ENA_IN_IDLE Inverter board error: GENERAL STATE ERROR, bit 5 - HV ENABLE SIGNAL ACTIVE IN IDLE MODE"	T	Reset error from AIS software on workstation; if error remains restart X-MIND trium and workstation; If error remains technical service is required.
102	C	"PRE_HEAT_NOT_FINISH Inverter board error: GENERAL STATE ERROR, bit 6 - FILAMENT PRE HEATING NOT COMPLETED"	T	Reset error from AIS software on workstation; if error remains restart X-MIND trium and workstation; If error remains technical service is required.
103	C	"OVER_VOLTAGE_ON_POS Inverter board error: GENERAL STATE ERROR, bit 8 - OVERVOLTAGE ON POSITIVE STAGE"	T	Reset error from AIS software on workstation; if error remains restart X-MIND trium and workstation; If error remains technical service is required.
104	C	"OVER_VOLTAGE_ON_NEG Inverter board error: GENERAL STATE ERROR, bit 9 - OVERVOLTAGE ON NEGATIVE STAGE"	T	Reset error from AIS software on workstation; if error remains restart X-MIND trium and workstation; If error remains technical service is required.

ENGLISH

105	C	"OVER_CURRENT_ON_POS Inverter board error: GENERAL STATE ERROR, bit 10 - OVERCURRENT ON POSITIVE STAGE"	T	Reset error from AIS software on workstation; if error remains restart X-MIND trium and workstation; If error remains technical service is required.
106	C	"OVER_CURRENT_ON_NEG Inverter board error: GENERAL STATE ERROR, bit 11 - OVERCURRENT ON NEGATIVE STAGE"	T	Reset error from AIS software on workstation; if error remains restart X-MIND trium and workstation; If error remains technical service is required.
107	C	"VOLT_LOW_LIM_ON_POS Inverter board error: GENERAL STATE ERROR, bit 12 - VOLTAGE TOO LOW ON POSITIVE STAGE"	T	Reset error from AIS software on workstation; if error remains restart X-MIND trium and workstation; If error remains technical service is required.
108	C	"VOLT_UPP_LIM_ON_POS Inverter board error: GENERAL STATE ERROR, bit 13 - VOLTAGE TOO HIGH ON POSITIVE STAGE"	T	Reset error from AIS software on workstation; if error remains restart X-MIND trium and workstation; If error remains technical service is required.
109	C	"VOLT_LOW_LIM_ON_NEG Inverter board error: GENERAL STATE ERROR, bit 14 - VOLTAGE TOO LOW ON NEGATIVE STAGE"	T	Reset error from AIS software on workstation; if error remains restart X-MIND trium and workstation; If error remains technical service is required.
110	C	"VOLT_UPP_LIM_ON_NEG Inverter board error: GENERAL STATE ERROR, bit 15 - VOLTAGE TOO HIGH ON NEGATIVE STAGE"	T	Reset error from AIS software on workstation; if error remains restart X-MIND trium and workstation; If error remains technical service is required.
111	C	"HI_VOLTS_ARC_ON_POS Inverter board error: GENERAL STATE ERROR, bit 16 - ARC DETECTED ON POSITIVE HV"	T	Reset error from AIS software on workstation; if error remains restart X-MIND trium and workstation; If error remains technical service is required.
112	C	"HI_VOLTS_ARC_ON_NEG Inverter board error: GENERAL STATE ERROR, bit 17 - ARC DETECTED ON NEGATIVE HV"	T	Reset error from AIS software on workstation; if error remains restart X-MIND trium and workstation; If error remains technical service is required.
113	C	"ANOD_CURRENT_ABSENT Inverter board error: GENERAL STATE ERROR, bit 19 - ANODIC CURRENT ABSENT"	T	Reset error from AIS software on workstation; if error remains restart X-MIND trium and workstation; If error remains technical service is required.
114	C	"ANOD_CURR_LOW_LIMIT Inverter board error: GENERAL STATE ERROR, bit 20 - ANODIC CURRENT TOO LOW"	T	Reset error from AIS software on workstation; if error remains restart X-MIND trium and workstation; If error remains technical service is required.
115	C	"ANOD_CURR_UPP_LIMIT Inverter board error: GENERAL STATE ERROR, bit 21 - ANODIC CURRENT TOO HIGH"	T	Reset error from AIS software on workstation; if error remains restart X-MIND trium and workstation; If error remains technical service is required.
116	C	"HEAT_SINK_OVER_TEMP Inverter board error: GENERAL STATE ERROR, bit 23 - HEAT SINK OVER TEMPERATURE"	T	Reset error from AIS software on workstation; if error remains restart X-MIND trium and workstation; If error remains technical service is required.

ENGLISH

117	C	"FILM_CURR_LOW_LIMIT Inverter board error: GENERAL STATE ERROR, bit 24 - FILAMENT CURRENT TOO LOW"	T	Reset error from AIS software on workstation; if error remains restart X-MIND trium and workstation; If error remains technical service is required.
118	C	"FILM_CURR_UPP_LIMIT Inverter board error: GENERAL STATE ERROR, bit 25 - FILAMENT CURRENT TOO HIGH"	T	Reset error from AIS software on workstation; if error remains restart X-MIND trium and workstation; If error remains technical service is required.
119	C	"EXP_TIME_IS_LOW_LIM Inverter board error: GENERAL STATE ERROR, bit 28 - EXPOSURE TIME TOO SHORT"	T	Reset error from AIS software on workstation; if error remains restart X-MIND trium and workstation; If error remains technical service is required.
120	C	"EXP_TIME_IS_UPP_LIM Inverter board error: GENERAL STATE ERROR, bit 29 - EXPOSURE TIME TOO LONG"	T	Reset error from AIS software on workstation; if error remains restart X-MIND trium and workstation; If error remains technical service is required.
121	C	"EXP_NUM_PLS_LOW_LIM Inverter board error: GENERAL STATE ERROR, bit 30 - TOO FEW EXPOSURES"	T	Reset error from AIS software on workstation; if error remains restart X-MIND trium and workstation; If error remains technical service is required.
122	C	"EXP_NUM_PLS_UPP_LIM Inverter board error: GENERAL STATE ERROR, bit 31 - TOO MANY EXPOSURES"	T	Reset error from AIS software on workstation; if error remains restart X-MIND trium and workstation; If error remains technical service is required.
123	C	"TUBEH_IS_NOT_DETECT Inverter board error: GENERAL STATE ERROR, bit 32 - RX TUBE UNIT NOT CONNECTED OR TEMPERATURE SENSOR FAULT"	T	Reset error from AIS software on workstation; if error remains restart X-MIND trium and workstation; If error remains technical service is required.
124	C	"TUBEH_OVER_TEMP_ERR Inverter board error: GENERAL STATE ERROR, bit 33 - RX TUBE UNIT OVER TEMPERATURE"	T	Reset error from AIS software on workstation; if error remains restart X-MIND trium and workstation; If error remains technical service is required.
125	C	"TUBEH_SENS_TEMP_ERR Inverter board error: GENERAL STATE ERROR, bit 34 - RX TUBE UNIT TEMPERATURE SENSOR FAULT"	T	Reset error from AIS software on workstation; if error remains restart X-MIND trium and workstation; If error remains technical service is required.
126	C	"NO_CURR_GENR_ON_POS Inverter board error: GENERAL STATE ERROR, bit 35 - NO CURRENT GENERATED BY POSITIVE HV STAGE"	T	Reset error from AIS software on workstation; if error remains restart X-MIND trium and workstation; If error remains technical service is required.
127	C	"NO_CURR_GENR_ON_NEG Inverter board error: GENERAL STATE ERROR, bit 36 - NO CURRENT GENERATED BY NEGATIVE HV STAGE"	T	Reset error from AIS software on workstation; if error remains restart X-MIND trium and workstation; If error remains technical service is required.
128	C	"IS_OVER_LOAD_ON_POS Inverter board error: GENERAL STATE ERROR, bit 37 - OVERLOAD ON POSITIVE HV STAGE"	T	Reset error from AIS software on workstation; if error remains restart X-MIND trium and workstation; If error remains technical service is required.

ENGLISH

129	C	"IS_OVER_LOAD_ON_NEG Inverter board error: GENERAL STATE ERROR, bit 38 - OVERLOAD ON NEGATIVE HV STAGE"	T	Reset error from AIS software on workstation; if error remains restart X-MIND trium and workstation; If error remains technical service is required.
130	C	"NO_FBACK_ON_POS_ERR Inverter board error: GENERAL STATE ERROR, bit 40 - NO FEEDBACK ON POSITIVE HV STAGE"	T	Reset error from AIS software on workstation; if error remains restart X-MIND trium and workstation; If error remains technical service is required.
131	C	"NO_FBACK_ON_NEG_ERR Inverter board error: GENERAL STATE ERROR, bit 41 - NO FEEDBACK ON NEGATIVE HV STAGE"	T	Reset error from AIS software on workstation; if error remains restart X-MIND trium and workstation; If error remains technical service is required.
133	C	"POWERDEV_LINK_ERROR CAN communication error between Mainboard and Power "	T	Reset error from AIS software on workstation; if error remains restart X-MIND trium and workstation; If error remains technical service is required.
134	C	"COL_DCFI_LINK_ERROR CAN communication error between Power and Hanning board (column board)"	T	Reset error from AIS software on workstation; if error remains restart X-MIND trium and workstation; If error remains technical service is required.
135	C	"PCF_VOLT_IS_UPP_LIM PFC over voltage detected"	A/T	Reset error from AIS software on workstation; if error remains restart X-MIND trium and workstation; If error remains technical service is required.
136	C	"PCF_VOLT_IS_LOW_LIM PFC under voltage detected"	A/T	Reset error from AIS software on workstation; if error remains restart X-MIND trium and workstation; If error remains technical service is required.
137	C	"PCF_TEMP_IS_UPP_LIM PFC over temperature detected"	A/T	Reset error from AIS software on workstation; if error remains restart X-MIND trium and workstation; If error remains technical service is required.
138	C	"PCF_TEMP_IS_LOW_LIM PFC under temperature detected"	A/T	Reset error from AIS software on workstation; if error remains restart X-MIND trium and workstation; If error remains technical service is required.
139	D	"EMERGENCY_STOP_DONE Trium has rebooted after releasing the emergency stop button"	U	Reset error from AIS software on workstation;
140	C	"COL_DCFI_LW_VOLTAGE Hanning board error code 1 - Under- voltage"	T	Reset error from AIS software on workstation; if error remains restart X-MIND trium and workstation; If error remains technical service is required.
141	C	"COL_DCFI_HI_VOLTAGE Hanning board error code 2 - Over- voltage"	T	Reset error from AIS software on workstation; if error remains restart X-MIND trium and workstation; If error remains technical service is required.
142	C	"COL_DCFI_HI_TEMPRAT Hanning board error code 5 - Over- heated motor or inverter"	T	Reset error from AIS software on workstation; if error remains restart X-MIND trium and workstation; If error remains technical service is required.
143	C	"COL_DCFI_HI_CURRENT Hanning board error code 9 - Inverter over-current / peak current error"	T	Reset error from AIS software on workstation; if error remains restart X-MIND trium and workstation; If error remains technical service is required.

ENGLISH

144	C	"COL_DCFI_SHORT_CIRC Hanning board error code 13 - Short-circuit – shut down"	T	Reset error from AIS software on workstation; if error remains restart X-MIND trium and workstation; If error remains technical service is required.
145	C	"COL_DCFI_IS_NOT_ENA Hanning board error code 16 - Not enabled"	T	Reset error from AIS software on workstation; if error remains restart X-MIND trium and workstation; If error remains technical service is required.
146	C	"COL_DCFI_TXCMD_TOUT Hanning board error code 17 - Time-out – digital interface"	T	Reset error from AIS software on workstation; if error remains restart X-MIND trium and workstation; If error remains technical service is required.
147	C	"COL_DCFI_ON_DIR_ERR Hanning board error code 18 - Start attempt with directional error"	T	Reset error from AIS software on workstation; if error remains restart X-MIND trium and workstation; If error remains technical service is required.
148	C	"COL_DCFI_TIMING_ERR Hanning board error code 128 - Internal timing error"	T	Reset error from AIS software on workstation; if error remains restart X-MIND trium and workstation; If error remains technical service is required.
149	C	"COL_DCFI_SYSTEM_ERR Hanning board error code 129 - System error"	T	Reset error from AIS software on workstation; if error remains restart X-MIND trium and workstation; If error remains technical service is required.
150	C	"COL_DCFI_WDOG_RESET Hanning board error code 131 - Reset by Watch Dog"	T	Reset error from AIS software on workstation; if error remains restart X-MIND trium and workstation; If error remains technical service is required.
151	C	"COL_DCFI_VDIP_RESET Hanning board error code 132 - Reset by voltage dip (brown-out)"	T	Reset error from AIS software on workstation; if error remains restart X-MIND trium and workstation; If error remains technical service is required.
152	C	"COL_DCFI_SFTW_RESET Hanning board error code 133 - Reset by SW"	T	Reset error from AIS software on workstation; if error remains restart X-MIND trium and workstation; If error remains technical service is required.
153	C	"COL_DCFI_E2PROM_CRC Hanning board error code 140 - Parameter memory CRC error"	T	Reset error from AIS software on workstation; if error remains restart X-MIND trium and workstation; If error remains technical service is required.
154	C	"COL_DCFI_E2PROM_TAB Hanning board error code 141 - Parameter memory table has an error"	T	Reset error from AIS software on workstation; if error remains restart X-MIND trium and workstation; If error remains technical service is required.
155	C	"COL_DCFI_DFLT_TABLE Hanning board error code 142 - Parameter memory factory default table has an error"	T	Reset error from AIS software on workstation; if error remains restart X-MIND trium and workstation; If error remains technical service is required.
156	C	"COLUMN_POS_WDG_TOUT Column motion stopped due to CAN communication timeout between Mainbord and Power"	T	Reset error from AIS software on workstation; if error remains restart X-MIND trium and workstation; If error remains technical service is required.
157	C	"COLUMN_POS_END_LIMI Column motion stopped because of the achievement of mechanical limit switches"	U/T	Reset error from AIS software on workstation. Move the column in the opposite direction. The equipment can be operated, but the occurrence of this error means that the column potentiometer is out of calibration; technical service is required:

ENGLISH

158	B	"COLUMN_POS_RUN_LIMI Column motion stopped because of the achievement of calibrated upper or lower position"	U	Only a warning: operator can move in the opposite direction.
159	C	"COLUMN_POT_REF_LIMI Reference value for column potentiometer is out of range"	T	Reset error from AIS software on workstation; if error remains restart X-MIND trium and workstation; If error remains technical service is required.
160	C	"COLUMN_POT_POS_LIMI Read value of column potentiometer is out of range"	T	Reset error from AIS software on workstation; if error remains restart X-MIND trium and workstation; If error remains technical service is required.
161	C	"COLUMN_POT_POS_BLK Column motion stopped because of the column potentiometer is blocked"	T	Reset error from AIS software on workstation; if error remains restart X-MIND trium and workstation; If error remains technical service is required.
163	C	"AUX_CBCT_LINK_ERROR CAN communication error between Mainboard and AUX CBCT board"	T	Reset error from AIS software on workstation; if error remains restart X-MIND trium and workstation; If error remains technical service is required.
164	B	"AUX_CEPH_LINK_ERROR CAN communication error between Mainboard and AUX CEPH board"	T	Reset error from AIS software on workstation; if error remains restart X-MIND trium and workstation; If error remains technical service is required.
165	C	"PRM_COLLIM_DO_BREAK WARNING: operator has intentionally stopped a movement releasing XRay button"	U	Wait the full exam procedure is completed before releasing XRay button: message on workstation "exposure button can be released"
166	C	"PRM_COLLIM_CNTL_FSM Unexpected primary collimator FSM condition"	A	Reset error from AIS software on workstation; if error remains restart X-MIND trium and workstation;
167	B	"VERT_INF_RESET_RAMP Unexpected FSM condition during reset of primary collimator vertical-inf axis"	A	Reset error from AIS software on workstation; if error remains restart X-MIND trium and workstation;
168	C	"VERT_INF_RESET_TOUT Timeout of primary collimator vertical-inf axis reset"	U/T	Reset error from AIS software on workstation; if error remains restart X-MIND trium and workstation; If error remains technical service is required.
169	C	"VERT_INF_PT_PT_GOTO The point-to-point positioning of vertical-inf axis of primary collimator is failed"	A	Reset error from AIS software on workstation; if error remains restart X-MIND trium and workstation;
170	B	"VERT_SUP_RESET_RAMP Unexpected FSM condition during reset of primary collimator vertical-sup axis"	A	Reset error from AIS software on workstation; if error remains restart X-MIND trium and workstation;
171	C	"VERT_SUP_RESET_TOUT Timeout of primary collimator vertical-sup axis reset"	U/T	Reset error from AIS software on workstation; if error remains restart X-MIND trium and workstation; If error remains technical service is required.
172	C	"VERT_SUP_PT_PT_GOTO The point-to-point positioning of vertical-sup axis of primary collimator is failed"	A	Reset error from AIS software on workstation; if error remains restart X-MIND trium and workstation;

ENGLISH

173	B	"HORZ_ONE_RESET_RAMP Unexpected FSM condition during reset of primary collimator horizontal axis"	A	Reset error from AIS software on workstation; if error remains restart X-MIND trium and workstation;
174	C	"HORZ_ONE_RESET_TOUT Timeout of primary collimator horizontal axis reset"	U/T	Reset error from AIS software on workstation; if error remains restart X-MIND trium and workstation; If error remains technical service is required.
175	C	"HORZ_ONE_PT_PT_GOTO The point-to-point positioning of horizontal axis of primary collimator is failed"	A	Reset error from AIS software on workstation; if error remains restart X-MIND trium and workstation;
177	C	"XRAYS_EXAM_DO_BREAK WARNING: operator has intentionally stopped the Xray emission releasing XRay button"	U	Wait the full exam procedure is completed before releasing XRay button: message onworkstation "exposure button can be released"

ENGLISH

11

ANNEXES

11.1 DEVICE POWER SUPPLY

Type of power supply	Single-phase alternating current power supply
Supply voltage	100 – 240 V
Maximum voltage variation	±10%
Frequency	50 – 60 Hz
Absorbed current (@ 90 kV, 10 mA)	7 A (@ 240 V) 15 A (@ 100 V)
Standby current	1 A
Maximum absorbed power	1500 VA
Line fuses	T 250 VH 10 A (for power supply range: 200 – 240 V) T 250 VH 20 A (for power supply range: 100 – 200 V)
Apparent resistance	0.2 Ω

11.2 ELECTRICAL CLASSIFICATION (IEC 60601-1)

Protection against electrical shock (insulation class)	Class I
Degree of protection against electrical shock (Applied part)	TYPE B
Use with flammable anaesthetics	Not evaluated for use in presence of flammable anaesthetic mixture with air, oxygen or nitrous oxide
Sterilization and disinfection methods	The device is supplied not sterile and it must not be subjected to sterilization
Operation mode	Continuous operation with intermittent X-ray loading
Installation type	Permanently Installed (fixed installation)

11.3 X-RAY ASSEMBLY AND X-RAY TUBE

X-RAY TUBE MODEL	CEI OPX/105
Nominal High Voltage	60 – 90 kV
Anode Material	Tungsten
Anode thermal capacity	30 kJ
Focal spot size (IEC 60336)	0.5 mm x 0.5 mm
Target angle	5°

ENGLISH

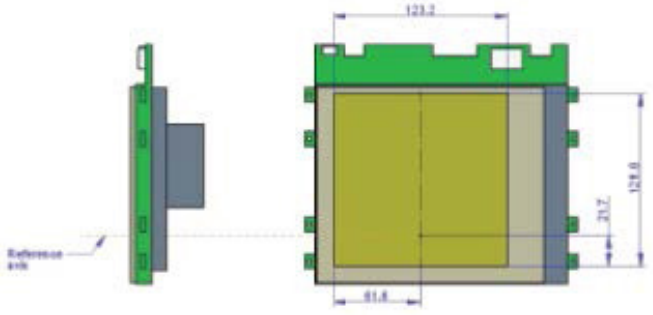
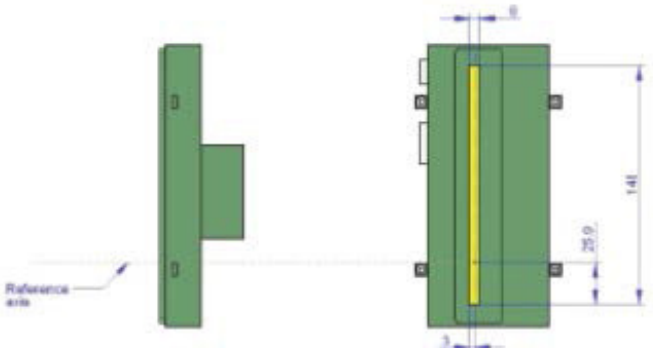
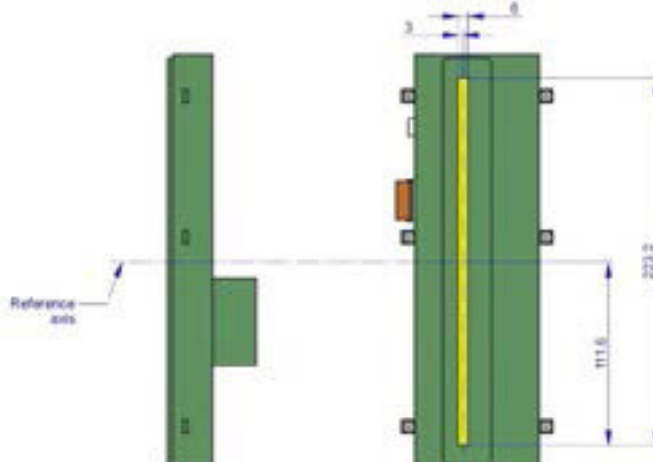
<p>Reference axis position</p>	<p>CBCT</p>  <p>PAN</p>  <p>CEPH</p> 
<p>HVL¹</p>	<p>3.4 mm Al for PAN/CEPH at 85 kV 5.2 mm Al for CBCT at 90 kV</p>
<p>Total filtration²</p>	<p>2.8 mm Al for PAN/CEPH at 85 kV 7.0 mm Al for CBCT at 90 kV</p>
<p>Inherent filtration</p>	<p>0.5 mm Al</p>
<p>Leakage radiation³</p>	<p>< 0.88 mGy/h @ 1 m</p>
<p>X-ray voltage accuracy</p>	<p>± 10%⁴</p>
<p>X-ray current accuracy</p>	<p>± 20%⁵</p>
<p>Radiation linearity</p>	<p>± 20%⁶</p>
<p>X-ray emission time accuracy</p>	<p>± (10% + 1 ms)⁷</p>

ENGLISH

Current-time product accuracy	$\pm (10\% + 0.2 \text{ mAs})^8$
Dose reproducibility ⁹	<0.05
Maximum anodic current	10 mA (typical 8 mA)
Loading factors related to the maximum specified energy input in one hour	Continuous mode: 85 kVp @ 10 mA
Nominal X-ray Tube Voltage together with the highest X-ray Tube Current obtainable from the High-Voltage Generator when operated at that X-ray Tube Voltage	Pulsed mode: 90kVp @ 10 mA
Highest X-ray Tube Current together with the highest X-ray Tube Voltage obtainable from the High-Voltage Generator when operating at that X-ray Tube Current	Pulsed mode: 10 mA 90 kVp
The Combination of X-ray Tube Voltage and X-ray Tube Current which results in the highest electric output power	Pulsed mode: 90 kVp @ 10 mA
The lowest Current Time Product or the combinations of Loading Factors resulting in the lowest Current Time Product	0.04 mAs per frame
Nominal electrical power	1.1 kW @ 90 kV, 10 mA, 0.1 s loading time
X-ray emission technology/ mode of operation	DC High Frequency PAN/CEPH: - Continuous X-ray loading. - Combinations of kV and mA along the whole maximum exposure time. (Maximum combination of loading factors in continuous mode is 85 kV @ 10 mA). CBCT: - Intermitting X-ray loading. - Combinations of kV and mA with a maximum combination of loading factors: 90 kV @ 10 mA.
Loading factors for Leakage radiation measurement	90 kVp @ 10 mA
Focal Spot-to-Skin distance ¹⁰	$\geq 150 \text{ mm}$

¹ IEC 60601-1-3 Par. 7.1 - 21 CFR 1020.30 (m)

² IEC 60601-1-3 Par. 7.1

³ 21 CFR 1020.30 (k)

⁴ IEC 60601-2-63 Par. 203.6.4.3.102.2 – 21 CFR 1020.31 (a) (4)

⁵ IEC 60601-2-63 Par. 203.6.4.3.102.3 – 21 CFR 1020.31 (a) (4)

⁶ IEC 60601-2-63 Par. 203.6.3.1.101 – 21 CFR 1020.31 (c)

⁷ IEC 60601-2-63 Par. 203.6.4.3.102.4 – 21 CFR 1020.31 (a) (4)

⁸ IEC 60601-2-63 Par. 203.6.4.3.102.5 – 21 CFR 1020.31 (a) (4)

⁹ IEC 60601-2-63 Par. 203.6.3.2.101 – 21 CFR 1020.31 (b)

¹⁰ IEC 60601-2-63 Par. 203.9 – 21 CFR 1020.31 (f)

11.4 DEGREE OF PROTECTION PROVIDED BY ENCLOSURES

According to the standard IEC 60529, the degree of protection is IP20

11.5 DEVICE MECHANICAL DATA

Dimensions	Footprint: Max 1505 x 1715 mm Height: 2358 mm
Weight	PAN: 170 kg PAN/CBCT: 185 kg PAN/CBCT With CEPH: 215 kg
Mechanical configuration	Wall mount / Self standing Left column/Right column Patient position: Standing, seated or on wheel-chair

11.6 WORKSTATION FEATURES

CBCT WORKSTATION PROVIDED BY THE MANUFACTURER	
CPU	6th Gen Intel(R) Core(TM) i5-6500 (Quad Core 3.2GHz)
Hard Disk	1 TB
Graphic Processor	NVIDIA (CUDA environment GPU family) Like : Quadro P2000
RAM	8 GB
NIC	Dedicated Gb Ethernet for X-MIND Trium Connection
Operating System	Windows 7 Professional 64 bit.
Certifications	IEC 60950-1, CISPR 22, CISPR 24

PAN/CEPH MINIMUM REQUIREMENTS	
CPU	INTEL I5 or superior
Hard Disk	1TB 7200 rpm or superior
Graphic Processor	OPEN GL 2.1 compatible (suggested an NVIDIA GT/GTX)
RAM	8 GB
NIC	INTEL CT 1000 pro
Operating System	Windows 7 Professional 64 bit or Windows 10 Professional 64 bit

11.7 DETECTORS

PAN/CEPH	
Detector technology	CMOS
Scintillator	Direct deposition CsI
Manufacturer	Hamamatsu Photonics K.K.
Model	PAN: FPD C10500D-43 CEPH: FPD C10502D-43G
Pixel size	100 µm
Active area	PAN: 148 mm x 6 mm CEPH: 223,2 mm x 6 mm

ENGLISH

Image size	PAN: 1480 px x 2658 px CEPH: 2232 px x 2673 px
Image format	PAN: 1480 mm x 2600 mm CEPH: 2000mm x 2200 mm, 2000mm x 1800 mm, 2400mm x 2200 mm, 2400mm x 1800 mm
Frame rate	300 frames/s
Sensitivity	12000 LSB/mR
Resolution	4.5 lp/mm
Dynamic range	4300
CBCT	
Detector technology	CMOS
Scintillator	Direct deposited CsI
Manufacturer	Hamamatsu Photonics K.K.
Model	FPD C12280D-40
Image voxel size	75 µm (minimum slice thickness)
Active area	121.6 x 123.1 mm
FOV (diameter x height)	40 mm x 60 mm 60 mm x 60 mm 80 mm x 80 mm 110 mm x 80 mm  NOTE : <i>A specific version of AIS software disables FOV 110mm X 80mm</i>
Frame rate	35 frames/s
Sensitivity	6000 LSB/mR
Resolution	2.5 lp/mm
Dynamic range	3600

11.8 SCANNING PARAMETERS – PAN/CEPH

X-ray exposure time	PAN: 3.3 s – 13.5 s / CEPH: 18 s
Scanning time	PAN: 16.8 s – 22.5 s / CEPH: 23 s
Tube voltage	60 – 85 kVp
Anodic current	4 – 10 mA

11.9 SCANNING PARAMETERS – CBCT

Scanning time	12 s – 30 s
Rotation	360°
X-ray real exposure time	6s (Standard quality) 7.2s (Medium quality) 9s (High quality)
Tube voltage	80 - 90 kVp
Anodic current	4 – 10 mA

11.10 LASER

Laser type	Line	Wavelength	Operating voltage	Class	Diffractive optics	Power	Positioning accuracy
PAN mid-sagittal from patient arm	Single line	635-650 nm	2.7 to 5 V	1M	Line, 90°	0.3 mW	<1mm
Canine from Tubehead	Single line	635-650 nm	2.7 to 5 V	1M	Line, 90°	0.3 mW	<1mm
Frankfurt from Tubehead	Multi-line	635-650 nm	2.7 to 5 V	3R	Line, 90°	0.3 - 2 mW	<1mm
CBCT mid-sagittal from U-arm	Single line	635-650 nm	2.7 to 5 V	1M	Line, 90°	0.3 mW	<1mm
CBCT coronal from Tubehead	Single line	635-650 nm	2.7 to 5 V	1M	Line, 90°	0.3 mW	<1mm
Axial (horizontal) from Tubehead.	Single line	635-650 nm	2.7 to 5 V	1M	Line, 90°	0.3 mW	<1mm

11.11 FIRMWARE DATA

Main board	0.44.3
Power board	0.10.3
Inverter board	2.4.0
AUX CBCT board	0.7.0
UX CEPH board	0.3.0
Image detectors	2.5.27

11.12 CLIENT PC MINIMUM REQUIREMENTS

IT'S MANDATORY TO RESPECT CLIENT PC MINIMUM REQUIREMENTS

	<p>THE CHOICE OF PC FOR AIS CLIENT, IS UNDER CUSTOMER RESPONSIBILITY. A WRONG CHOICE, WITHOUT RESPECTING MINIMUM REQUIREMENT, WILL NOT BE UNDER ACTEON GROUP RESPONSIBILITY.</p>
---	--

Please, take care about workstation minimum requirement to avoid faults, errors, misfunctionality and/or problem during the installation, connection and use of X-MIND Trium.

CLIENT:

WINDOWS OS BASED HARDWARE

Processor: Intel I5 or I7 (notebooks), Quad Core suggested (for Workstations)

RAM: minimum 4 GB, for big FOV DICOM stacks it is suggested to install 8 GB

Hard disk: minimum 300 GB (for image storage, the software alone occupies 200 MB, the full implant library is 7 Gb size)

Graphic card: Nvidia Geforce product range with 1 Gb dedicated RAM (notebooks) or Nvidia Quadro with dedicated memory (workstations)

Screen resolution: minimum height 1024 and width 1600, it is suggested to use higher resolutions for optimal planning (full HD: 1920 x 1080)

O/S: Windows 7 (64 bit), Windows 10 (64 bit).

MAC OS BASED HARDWARE

Macbook PRO product line or

iMac product line with the following or equivalent characteristics:

RAM: minimum 4 GB, for big FOV DICOM stacks it is suggested to install 8 GB.

Hard disk: minimum 300 GB (for image storage, the software alone occupies 200 MB, the full implant library is 7 Gb size)

Graphic card for optimal performance: Nvidia Geforce product range or Nvidia Quadro with 1 Gb dedicated RAM.

Screen resolution: minimum height 1024 and width 1600, it is suggested to use higher resolutions for optimal planning (full HD: 1920 x 1080)

O/S: OS X Sierra (10.12).

Network Cards :

A LAN network must be used for the connection between client and server.

Avoid to use a wireless network card on the client : fast connection network (LAN type) are needed to share the patient exams with the clients PCs. Due to this, a WiFi network card could be too slow to transfer patient exams with clients PCs.

OTHER SOFTWARE :

• If you install an antivirus or firewall or internet security in the workstation, take care of these specific :

- All the AIS processes have to be excluded in AV the exclusion list

- All the ports used by AIS (from 51000 to 51020, and 6543) have to be opened in the firewall

- If you face other problems or you are not able to configure AV or firewall, please disable them.

	<p>PAY ATTENTION TO DON'T HAVE AIS WORKSTATION SOFTWARE VERSION ALREADY INSTALLED IN THE MACHINE. OTHERWISE YOU WILL HAVE PROBLEM IN THE INSTALLATION AND IN THE CONFIGURATION AIS CLIENT VERSION !</p>
--	--

11.13 INTENDED ENVIRONMENT

Clinical environment conditions (use conditions):

- Temperature: 10 to 30°C
- Relative humidity: 25 to 75 %
- Atmospheric pressure: 850 to 1060 hPa

Transportation environment conditions:

- Temperature: 0 to 50°C
- Relative humidity: See clinical environment conditions
- Atmospheric pressure: 500 to 1060 hPa

Warehousing environment conditions:

- See Transportation environment conditions

11.14 DIMENSIONS OF THE UNIT

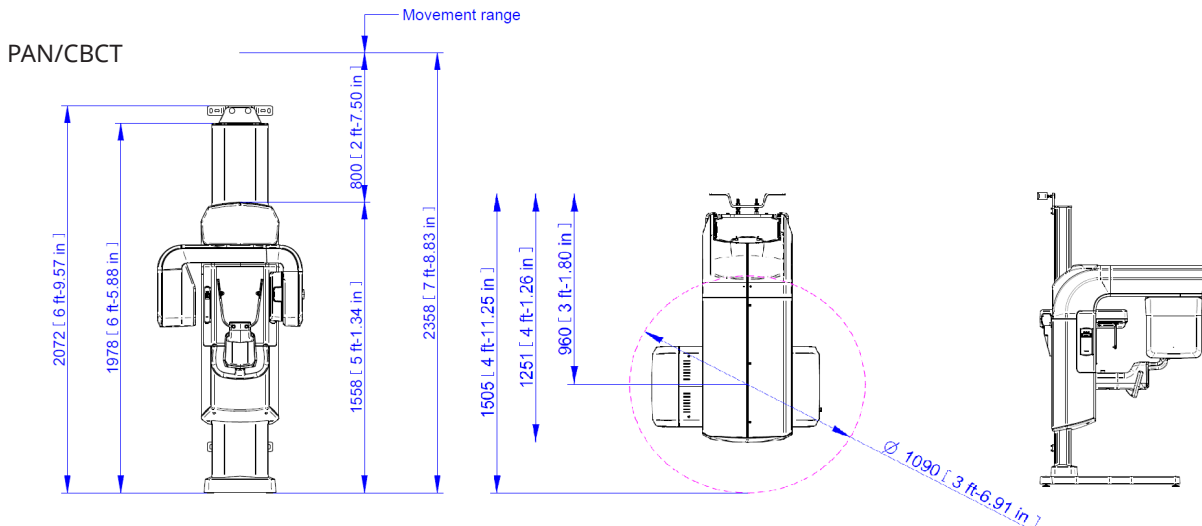

ENGLISH

CEPH

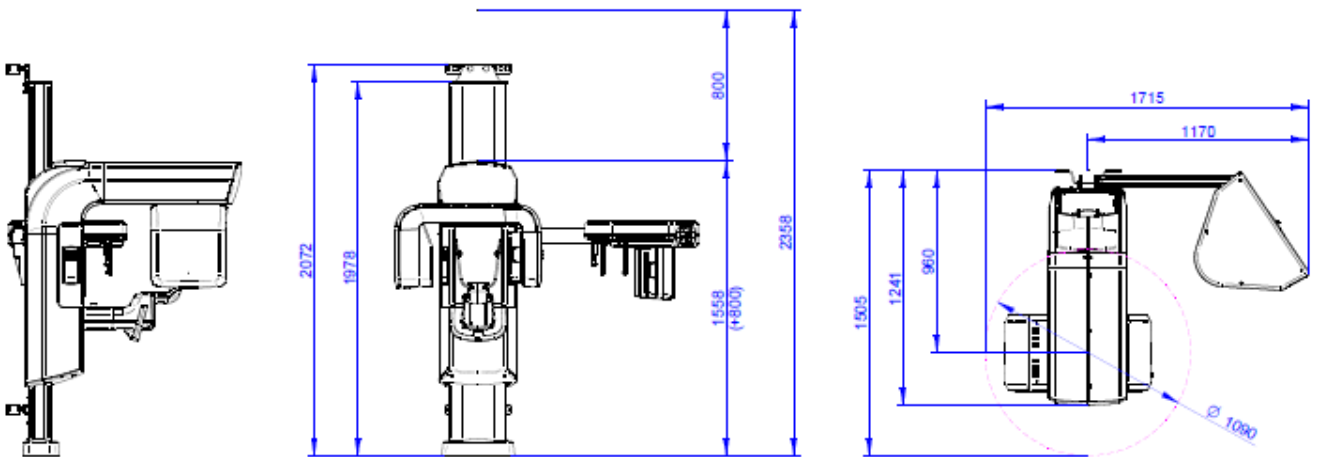
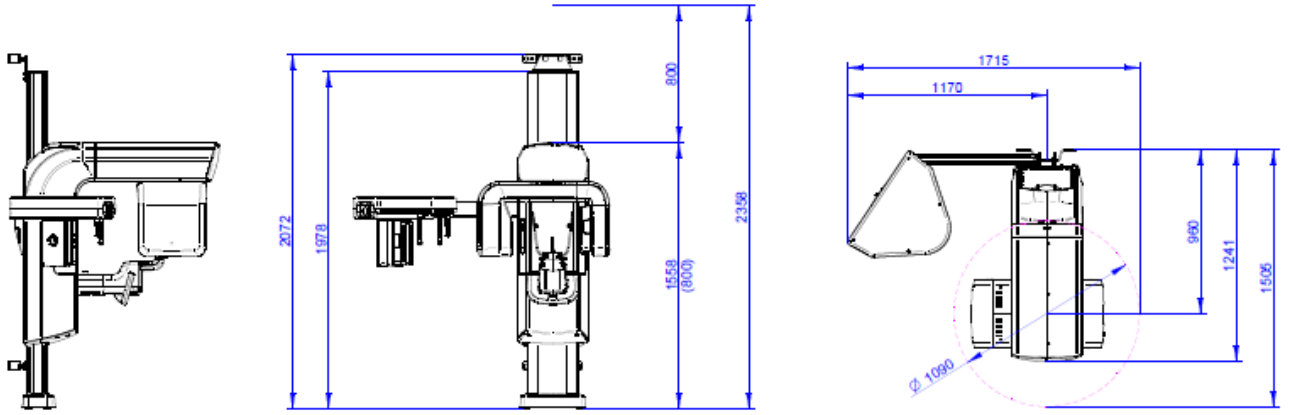

WITH SELF STANDING

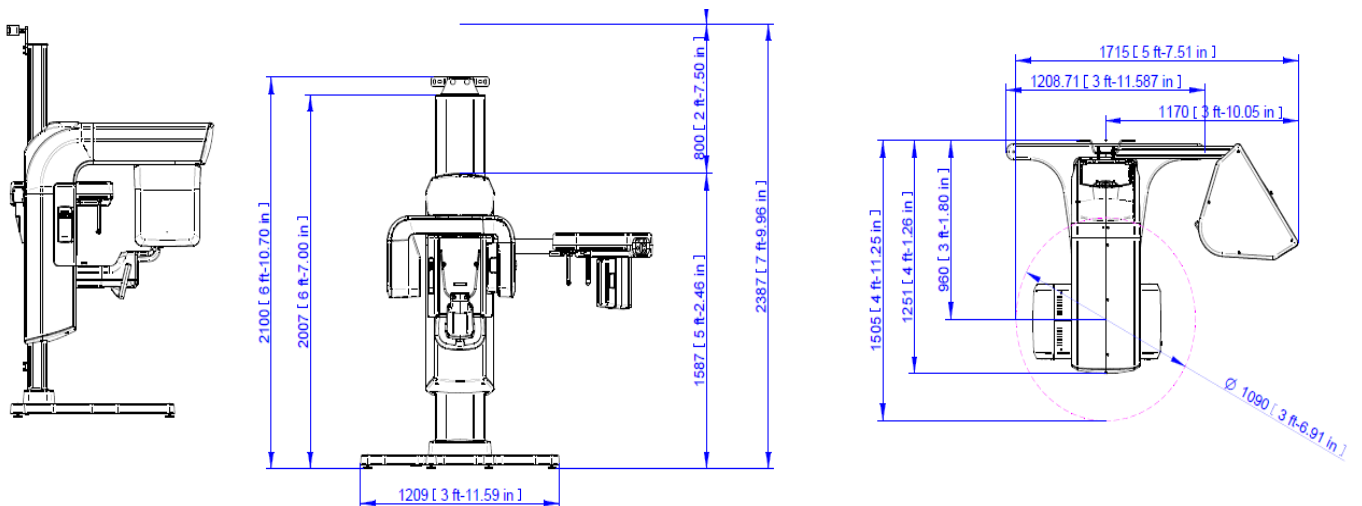

11.15 LIST OF INTERNATIONAL STANDARDS AND DIRECTIVES

The system is classified as:

Directive	MDD 93/42 EEC Annex IX, article 10	21CFR 892.1750	SOR 98/282 rule 8	TG(MD) Regulations 2002 Schedule 2 part 4.3	Pharmaceuticals and Medical Devices Act [Table 1]
Class	I Ib	II	III	I Ib	II

IEC/EN 60601-1:2005, 3rd edition

IEC/EN 60601-1-3:2008,

IEC/EN 60601-1-6:2010,

IEC 62366: 2007

IEC 60601-2-63:2012

ANSI/AAMI ES60601-1:2005

CAN/CSA-C222.2 N. 60601-1:08

IEC/EN 60601-2: 2007

21 CFR 1020.30

21 CFR 1020.31

21 CFR 1020.33

11.16 DOSIMETRIC INDICATIONS

The following tables provides dosimetric indications related to the execution of radiographic exams by the X-MIND trium.

The radiation dose is reported in terms of Dose Area Product (DAP), which takes into account the size of the X-ray beam and its intensity, providing a thorough dose index; in detail, the DAP is computed by multiplying the Air Kerma measured by the X-ray beam area at the measurement location.

The DAP is considered beneficial for the following reasons:

- It is dependent by the typology of beam limiting device installed and in use
- It is independent by the measured location, that is the distance from the focal spot

This section reports the value of radiation dose for every type of exam and any combination of loading factors.

Typically, these dosimetric indications represents a reference for the operators to adjust or modify the loading factors during the process of optimization of the scanning protocol; in addition, these values might be used for dosimetric check during installation or periodic maintenance to assess the proper functioning of the device.

ENGLISH

DAP values for PANORAMIC exams

Tube voltage	Anodic current	PAN standard	PAN standard Right/Left	PAN orthogonal	PAN orthogonal Right/Left	PAN frontal	Bitewings	PAN Motor Child	TMJ frontal	TMJ frontal Right/Left	TMJ lateral	TMJ lateral Right/Left	TMJ standard	SINUS frontal	SINUS lateral Right/Left
Exposure Time [s]	[mA]	13,5	7,28	8,2	4,98	4,24	7,9	12,38	7,16	10,74	7,16	10,74	14,34	6,94	2,9
[kV]	[mGycm2]														
60	4	28,9	15,6	17,5	10,6	9,1	11,6	23,5	15,3	23,0	15,3	23,0	30,6	14,8	6,2
60	5	36,1	19,4	21,9	13,3	11,3	14,5	29,4	19,1	28,7	19,1	28,7	38,3	18,5	7,7
60	6	43,3	23,3	26,3	16,0	13,6	17,4	35,3	23,0	34,4	23,0	34,4	46,0	22,2	9,3
60	7	50,5	27,2	30,7	18,6	15,9	20,3	41,2	26,8	40,2	26,8	40,2	53,6	26,0	10,8
60	8	57,7	31,1	35,1	21,3	18,1	23,2	47,1	30,6	45,9	30,6	45,9	61,3	29,7	12,4
60	9	64,9	35,0	39,4	23,9	20,4	26,1	53,0	34,4	51,6	34,4	51,6	69,0	33,4	13,9
60	10	72,1	38,9	43,8	26,6	22,7	29,0	58,9	38,3	57,4	38,3	57,4	76,6	37,1	15,5
61	4	30,4	16,4	18,5	11,2	9,6	12,0	24,7	16,1	24,2	16,1	24,2	32,3	15,7	6,5
61	5	38,1	20,5	23,1	14,0	12,0	15,0	30,9	20,2	30,3	20,2	30,3	40,4	19,6	8,2
61	6	45,7	24,6	27,7	16,8	14,3	18,0	37,0	24,2	36,3	24,2	36,3	48,5	23,5	9,8
61	7	53,3	28,7	32,4	19,7	16,7	21,0	43,2	28,3	42,4	28,3	42,4	56,6	27,4	11,4
61	8	60,9	32,8	37,0	22,5	19,1	24,1	49,4	32,3	48,4	32,3	48,4	64,7	31,3	13,1
61	9	68,5	36,9	41,6	25,3	21,5	27,1	55,5	36,3	54,5	36,3	54,5	72,8	35,2	14,7
61	10	76,1	41,0	46,2	28,1	23,9	30,1	61,7	40,4	60,6	40,4	60,6	80,9	39,1	16,4
62	4	32,0	17,3	19,5	11,8	10,1	12,5	25,8	17,0	25,5	17,0	25,5	34,0	16,5	6,9
62	5	40,0	21,6	24,3	14,8	12,6	15,6	32,3	21,2	31,9	21,2	31,9	42,5	20,6	8,6
62	6	48,1	25,9	29,2	17,7	15,1	18,7	38,7	25,5	38,2	25,5	38,2	51,0	24,7	10,3
62	7	56,1	30,2	34,1	20,7	17,6	21,8	45,2	29,7	44,6	29,7	44,6	59,6	28,8	12,0
62	8	64,1	34,6	38,9	23,6	20,1	24,9	51,7	34,0	51,0	34,0	51,0	68,1	32,9	13,8
62	9	72,1	38,9	43,8	26,6	22,6	28,0	58,1	38,2	57,3	38,2	57,3	76,6	37,1	15,5
62	10	80,1	43,2	48,7	29,5	25,2	31,1	64,6	42,5	63,7	42,5	63,7	85,1	41,2	17,2
63	4	33,6	18,1	20,4	12,4	10,6	12,9	27,0	17,8	26,8	17,8	26,8	35,7	17,3	7,2
63	5	42,0	22,7	25,5	15,5	13,2	16,1	33,7	22,3	33,4	22,3	33,4	44,7	21,6	9,0
63	6	50,4	27,2	30,6	18,6	15,8	19,3	40,5	26,8	40,1	26,8	40,1	53,6	25,9	10,8
63	7	58,9	31,7	35,7	21,7	18,5	22,5	47,2	31,2	46,8	31,2	46,8	62,5	30,3	12,6
63	8	67,3	36,3	40,9	24,8	21,1	25,8	53,9	35,7	53,5	35,7	53,5	71,4	34,6	14,4
63	9	75,7	40,8	46,0	27,9	23,8	29,0	60,7	40,1	60,2	40,1	60,2	80,4	38,9	16,3
63	10	84,1	45,3	51,1	31,0	26,4	32,2	67,4	44,6	66,9	44,6	66,9	89,3	43,2	18,1
64	4	35,2	19,0	21,4	13,0	11,1	13,3	28,1	18,7	28,0	18,7	28,0	37,4	18,1	7,6
64	5	44,0	23,7	26,7	16,2	13,8	16,6	35,1	23,4	35,0	23,4	35,0	46,8	22,6	9,5
64	6	52,8	28,5	32,1	19,5	16,6	20,0	42,2	28,0	42,0	28,0	42,0	56,1	27,2	11,3
64	7	61,6	33,2	37,4	22,7	19,4	23,3	49,2	32,7	49,0	32,7	49,0	65,5	31,7	13,2
64	8	70,4	38,0	42,8	26,0	22,1	26,6	56,2	37,4	56,0	37,4	56,0	74,8	36,2	15,1
64	9	79,3	42,7	48,1	29,2	24,9	29,9	63,3	42,0	63,0	42,0	63,0	84,2	40,7	17,0
64	10	88,1	47,5	53,5	32,5	27,7	33,3	70,3	46,7	70,1	46,7	70,1	93,5	45,3	18,9
65	4	36,8	19,9	22,4	13,6	11,6	13,7	29,3	19,5	29,3	19,5	29,3	39,1	18,9	7,9
65	5	46,0	24,8	28,0	17,0	14,5	17,2	36,6	24,4	36,6	24,4	36,6	48,9	23,7	9,9
65	6	55,2	29,8	33,5	20,4	17,3	20,6	43,9	29,3	43,9	29,3	43,9	58,7	28,4	11,9
65	7	64,4	34,7	39,1	23,8	20,2	24,0	51,2	34,2	51,3	34,2	51,3	68,4	33,1	13,8
65	8	73,6	39,7	44,7	27,2	23,1	27,5	58,5	39,1	58,6	39,1	58,6	78,2	37,9	15,8
65	9	82,8	44,7	50,3	30,6	26,0	30,9	65,8	43,9	65,9	43,9	65,9	88,0	42,6	17,8
65	10	92,0	49,6	55,9	34,0	28,9	34,3	73,1	48,8	73,2	48,8	73,2	97,8	47,3	19,8
66	4	38,4	20,7	23,3	14,2	12,1	14,2	30,4	20,4	30,6	20,4	30,6	40,8	19,7	8,3
66	5	48,0	25,9	29,2	17,7	15,1	17,7	38,0	25,5	38,2	25,5	38,2	51,0	24,7	10,3
66	6	57,6	31,1	35,0	21,3	18,1	21,2	45,6	30,6	45,8	30,6	45,8	61,2	29,6	12,4
66	7	67,2	36,2	40,8	24,8	21,1	24,8	53,2	35,6	53,5	35,6	53,5	71,4	34,6	14,4
66	8	76,8	41,4	46,7	28,3	24,1	28,3	60,8	40,7	61,1	40,7	61,1	81,6	39,5	16,5
66	9	86,4	46,6	52,5	31,9	27,1	31,9	68,4	45,8	68,8	45,8	68,8	91,8	44,4	18,6
66	10	96,0	51,8	58,3	35,4	30,2	35,4	76,0	50,9	76,4	50,9	76,4	102,0	49,4	20,6
67	4	40,0	21,6	24,3	14,8	12,6	14,6	31,5	21,2	31,8	21,2	31,8	42,5	20,6	8,6
67	5	50,0	27,0	30,4	18,4	15,7	18,2	39,4	26,5	39,8	26,5	39,8	53,1	25,7	10,7
67	6	60,0	32,4	36,4	22,1	18,8	21,9	47,3	31,8	47,7	31,8	47,7	63,7	30,8	12,9
67	7	70,0	37,7	42,5	25,8	22,0	25,5	55,2	37,1	55,7	37,1	55,7	74,4	36,0	15,0
67	8	80,0	43,1	48,6	29,5	25,1	29,2	63,1	42,4	63,6	42,4	63,6	85,0	41,1	17,2
67	9	90,0	48,5	54,7	33,2	28,3	32,8	71,0	47,7	71,6	47,7	71,6	95,6	46,3	19,3
67	10	100,0	53,9	60,7	36,9	31,4	36,5	78,9	53,0	79,6	53,0	79,6	106,2	51,4	21,5
68	4	41,6	22,4	25,3	15,3	13,1	15,0	32,7	22,1	33,1	22,1	33,1	44,2	21,4	8,9
68	5	52,0	28,0	31,6	19,2	16,3	18,8	40,9	27,6	41,4	27,6	41,4	55,2	26,7	11,2
68	6	62,4	33,6	37,9	23,0	19,6	22,5	49,0	33,1	49,6	33,1	49,6	66,3	32,1	13,4
68	7	72,8	39,3	44,2	26,9	22,9	26,3	57,2	38,6	57,9	38,6	57,9	77,3	37,4	15,6
68	8	83,2	44,9	50,5	30,7	26,1	30,0	65,4	44,1	66,2	44,1	66,2	88,4	42,8	17,9
68	9	93,6	50,5	56,8	34,5	29,4	33,8	73,6	49,6	74,5	49,6	74,5	99,4	48,1	20,1
68	10	104,0	56,1	63,2	38,4	32,7	37,5	81,7	55,1	82,7	55,1	82,7	110,5	53,5	22,3
69	4	43,2	23,3	26,2	15,9	13,6	15,4	33,8	22,9	34,4	22,9	34,4	45,9	22,2	9,3
69	5	54,0	29,1	32,8	19,9	17,0	19,3	42,3	28,6	42,9	28,6	42,9	57,3	27,8	11,6
69	6	64,8	34,9	39,3	23,9	20,3	23,2	50,8	34,4	51,5	34,4	51,5	68,8	33,3	13,9
69	7	75,6	40,8	45,9	27,9	23,7	27,0	59,2	40,1	60,1	40,1	60,1	80,3	38,9	16,2
69	8	86,4	46,6	52,5	31,9	27,1	30,9	67,7	45,8	68,7	45,8	68,7	91,7	44,4	18,6
69	9	97,2	52,4	59,0	35,8	30,5	34,7	76,1	51,5	77,3	51,5	77,3	103,2	50,0	20,9
69	10	108,0	58,2	65,6	39,8	33,9	38,6	84,6	57,3	85,9	57,3	85,9	114,7	55,5	23,2
70	4	44,8	24,1	27,2	16,5	14,1	15,9	35,0	23,7	35,6	23,7	35,6	47,6	23,0	9,6
70	5	56,0	30,2	34,0	20,6	17,6	19,8	43,7	29,7	44,5	29,7	44,5	59,5	28,8	12,0

ENGLISH

Tube voltage	Anodic current	PAN standard	PAN standard Right/Left	PAN orthogonal	PAN orthogonal Right/Left	PAN frontal	Bitewings	PAN Motor Child	TMJ frontal	TMJ frontal Right/Left	TMJ lateral	TMJ lateral Right/Left	TMJ standard	SINUS frontal	SINUS lateral Right/Left
Exposure Time [s]	[mA]	13,5	7,28	8,2	4,98	4,24	7,9	12,38	7,16	10,74	7,16	10,74	14,34	6,94	2,9
[kV]	[mGycm2]														
70	6	67,2	36,2	40,8	24,8	21,1	23,8	52,5	35,6	53,4	35,6	53,4	71,3	34,5	14,4
70	7	78,4	42,3	47,6	28,9	24,6	27,8	61,2	41,6	62,3	41,6	62,3	83,2	40,3	16,8
70	8	89,6	48,3	54,4	33,0	28,1	31,7	70,0	47,5	71,2	47,5	71,2	95,1	46,0	19,2
70	9	100,8	54,3	61,2	37,2	31,6	35,7	78,7	53,4	80,2	53,4	80,2	107,0	51,8	21,6
70	10	111,9	60,4	68,0	41,3	35,2	39,7	87,4	59,4	89,1	59,4	89,1	118,9	57,5	24,0
71	4	46,4	25,0	28,2	17,1	14,6	16,3	36,1	24,6	36,9	24,6	36,9	49,3	23,8	10,0
71	5	58,0	31,3	35,2	21,4	18,2	20,4	45,2	30,7	46,1	30,7	46,1	61,6	29,8	12,5
71	6	69,6	37,5	42,2	25,7	21,8	24,4	54,2	36,9	55,3	36,9	55,3	73,9	35,8	14,9
71	7	81,1	43,8	49,3	29,9	25,5	28,5	63,2	43,0	64,6	43,0	64,6	86,2	41,7	17,4
71	8	92,7	50,0	56,3	34,2	29,1	32,6	72,2	49,2	73,8	49,2	73,8	98,5	47,7	19,9
71	9	104,3	56,3	63,4	38,5	32,8	36,7	81,3	55,3	83,0	55,3	83,0	110,8	53,6	22,4
71	10	115,9	62,5	70,4	42,8	36,4	40,7	90,3	61,5	92,2	61,5	92,2	123,1	59,6	24,9
72	4	48,0	25,9	29,1	17,7	15,1	16,7	37,3	25,4	38,2	25,4	38,2	50,9	24,7	10,3
72	5	60,0	32,3	36,4	22,1	18,8	20,9	46,6	31,8	47,7	31,8	47,7	63,7	30,8	12,9
72	6	71,9	38,8	43,7	26,5	22,6	25,1	55,9	38,2	57,2	38,2	57,2	76,4	37,0	15,5
72	7	83,9	45,3	51,0	31,0	26,4	29,3	65,2	44,5	66,8	44,5	66,8	89,2	43,1	18,0
72	8	95,9	51,7	58,3	35,4	30,1	33,4	74,5	50,9	76,3	50,9	76,3	101,9	49,3	20,6
72	9	107,9	58,2	65,5	39,8	33,9	37,6	83,8	57,2	85,9	57,2	85,9	114,6	55,5	23,2
72	10	119,9	64,7	72,8	44,2	37,7	41,8	93,2	63,6	95,4	63,6	95,4	127,4	61,6	25,8
73	4	49,6	26,7	30,1	18,3	15,6	17,1	38,4	26,3	39,4	26,3	39,4	52,6	25,5	10,6
73	5	61,9	33,4	37,6	22,9	19,5	21,4	48,0	32,9	49,3	32,9	49,3	65,8	31,8	13,3
73	6	74,3	40,1	45,2	27,4	23,3	25,7	57,6	39,4	59,1	39,4	59,1	79,0	38,2	16,0
73	7	86,7	46,8	52,7	32,0	27,2	30,0	67,2	46,0	69,0	46,0	69,0	92,1	44,6	18,6
73	8	99,1	53,4	60,2	36,6	31,1	34,3	76,8	52,6	78,8	52,6	78,8	105,3	51,0	21,3
73	9	111,5	60,1	67,7	41,1	35,0	38,6	86,4	59,1	88,7	59,1	88,7	118,4	57,3	24,0
73	10	123,9	66,8	75,3	45,7	38,9	42,9	96,0	65,7	98,6	65,7	98,6	131,6	63,7	26,6
74	4	51,1	27,6	31,1	18,9	16,1	17,6	39,6	27,1	40,7	27,1	40,7	54,3	26,3	11,0
74	5	63,9	34,5	38,8	23,6	20,1	22,0	49,4	33,9	50,9	33,9	50,9	67,9	32,9	13,7
74	6	76,7	41,4	46,6	28,3	24,1	26,4	59,3	40,7	61,0	40,7	61,0	81,5	39,4	16,5
74	7	89,5	48,3	54,4	33,0	28,1	30,8	69,2	47,5	71,2	47,5	71,2	95,1	46,0	19,2
74	8	102,3	55,2	62,1	37,7	32,1	35,1	79,1	54,3	81,4	54,3	81,4	108,7	52,6	22,0
74	9	115,1	62,1	69,9	42,5	36,1	39,5	89,0	61,0	91,6	61,0	91,6	122,2	59,2	24,7
74	10	127,9	69,0	77,7	47,2	40,2	43,9	98,9	67,8	101,7	67,8	101,7	135,8	65,7	27,5
75	4	52,7	28,4	32,0	19,5	16,6	18,0	40,7	28,0	42,0	28,0	42,0	56,0	27,1	11,3
75	5	65,9	35,6	40,0	24,3	20,7	22,5	50,9	35,0	52,4	35,0	52,4	70,0	33,9	14,2
75	6	79,1	42,7	48,1	29,2	24,8	27,0	61,0	42,0	62,9	42,0	62,9	84,0	40,7	17,0
75	7	92,3	49,8	56,1	34,0	29,0	31,5	71,2	49,0	73,4	49,0	73,4	98,0	47,4	19,8
75	8	105,5	56,9	64,1	38,9	33,1	36,0	81,4	55,9	83,9	55,9	83,9	112,0	54,2	22,7
75	9	118,7	64,0	72,1	43,8	37,3	40,5	91,6	62,9	94,4	62,9	94,4	126,0	61,0	25,5
75	10	131,9	71,1	80,1	48,6	41,4	45,0	101,7	69,9	104,9	69,9	104,9	140,1	67,8	28,3
76	4	54,3	29,3	33,0	20,0	17,1	18,4	41,8	28,8	43,2	28,8	43,2	57,7	27,9	11,7
76	5	67,9	36,6	41,3	25,1	21,3	23,0	52,3	36,0	54,0	36,0	54,0	72,1	34,9	14,6
76	6	81,5	43,9	49,5	30,1	25,6	27,6	62,8	43,2	64,8	43,2	64,8	86,6	41,9	17,5
76	7	95,1	51,3	57,8	35,1	29,9	32,2	73,2	50,4	75,6	50,4	75,6	101,0	48,9	20,4
76	8	108,7	58,6	66,0	40,1	34,1	36,8	83,7	57,6	86,4	57,6	86,4	115,4	55,9	23,3
76	9	122,2	65,9	74,3	45,1	38,4	41,5	94,1	64,8	97,3	64,8	97,3	129,9	62,8	26,3
76	10	135,8	73,2	82,5	50,1	42,7	46,1	104,6	72,0	108,1	72,0	108,1	144,3	69,8	29,2
77	4	55,9	30,2	34,0	20,6	17,6	18,9	43,0	29,7	44,5	29,7	44,5	59,4	28,7	12,0
77	5	69,9	37,7	42,5	25,8	22,0	23,6	53,7	37,1	55,6	37,1	55,6	74,3	35,9	15,0
77	6	83,9	45,2	51,0	30,9	26,3	28,3	64,5	44,5	66,7	44,5	66,7	89,1	43,1	18,0
77	7	97,9	52,8	59,4	36,1	30,7	33,0	75,2	51,9	77,9	51,9	77,9	104,0	50,3	21,0
77	8	111,8	60,3	67,9	41,3	35,1	37,7	86,0	59,3	89,0	59,3	89,0	118,8	57,5	24,0
77	9	125,8	67,9	76,4	46,4	39,5	42,4	96,7	66,7	100,1	66,7	100,1	133,7	64,7	27,0
77	10	139,8	75,4	84,9	51,6	43,9	47,1	107,5	74,2	111,2	74,2	111,2	148,5	71,9	30,0
78	4	57,5	31,0	34,9	21,2	18,1	19,3	44,1	30,5	45,8	30,5	45,8	61,1	29,6	12,4
78	5	71,9	38,8	43,7	26,5	22,6	24,1	55,2	38,1	57,2	38,1	57,2	76,4	37,0	15,4
78	6	86,3	46,5	52,4	31,8	27,1	28,9	66,2	45,8	68,6	45,8	68,6	91,6	44,4	18,5
78	7	100,7	54,3	61,1	37,1	31,6	33,7	77,2	53,4	80,1	53,4	80,1	106,9	51,7	21,6
78	8	115,0	62,0	69,9	42,4	36,1	38,6	88,3	61,0	91,5	61,0	91,5	122,2	59,1	24,7
78	9	129,4	69,8	78,6	47,7	40,6	43,4	99,3	68,6	103,0	68,6	103,0	137,5	66,5	27,8
78	10	143,8	77,5	87,3	53,0	45,2	48,2	110,3	76,3	114,4	76,3	114,4	152,7	73,9	30,9
79	4	59,1	31,9	35,9	21,8	18,6	19,7	45,3	31,4	47,0	31,4	47,0	62,8	30,4	12,7
79	5	73,9	39,8	44,9	27,3	23,2	24,6	56,6	39,2	58,8	39,2	58,8	78,5	38,0	15,9
79	6	88,7	47,8	53,9	32,7	27,8	29,6	67,9	47,0	70,5	47,0	70,5	94,2	45,6	19,0
79	7	103,4	55,8	62,8	38,2	32,5	34,5	79,2	54,9	82,3	54,9	82,3	109,9	53,2	22,2
79	8	118,2	63,8	71,8	43,6	37,1	39,4	90,5	62,7	94,1	62,7	94,1	125,6	60,8	25,4
79	9	133,0	71,7	80,8	49,1	41,8	44,3	101,9	70,5	105,8	70,5	105,8	141,3	68,4	28,6
79	10	147,8	79,7	89,8	54,5	46,4	49,3	113,2	78,4	117,6	78,4	117,6	157,0	76,0	31,7
80	4	60,7	32,7	36,9	22,4	19,1	20,1	46,4	32,2	48,3	32,2	48,3	64,5	31,2	13,0
80	5	75,9	40,9	46,1	28,0	23,8	25,2	58,0	40,2	60,4	40,2	60,4	80,6	39,0	16,3
80	6	91,1	49,1	55,3	33,6	28,6	30,2	69,6	48,3	72,4	48,3	72,4	96,7	46,8	19,6
80	7	106,2	57,3	64,5	39,2	33,4	35,2	81,2	56,3	84,5	56,3	84,5	112,8	54,6	22,8

ENGLISH

Tube voltage	Anodic current	PAN standard	PAN standard Right/Left	PAN orthogonal	PAN orthogonal Right/Left	PAN frontal	Bitewings	PAN Motor Child	TMJ frontal	TMJ frontal Right/Left	TMJ lateral	TMJ lateral Right/Left	TMJ standard	SINUS frontal	SINUS lateral Right/Left
Exposure Time	[s]	13,5	7,28	8,2	4,98	4,24	7,9	12,38	7,16	10,74	7,16	10,74	14,34	6,94	2,9
[kV]	[mA]	[mGycm2]													
80	8	121,4	65,5	73,7	44,8	38,1	40,3	92,8	64,4	96,6	64,4	96,6	129,0	62,4	26,1
80	9	136,6	73,7	83,0	50,4	42,9	45,3	104,4	72,4	108,7	72,4	108,7	145,1	70,2	29,3
80	10	151,8	81,8	92,2	56,0	47,7	50,3	116,0	80,5	120,7	80,5	120,7	161,2	78,0	32,6
81	4	62,3	33,6	37,8	23,0	19,6	20,6	47,6	33,0	49,6	33,0	49,6	66,2	32,0	13,4
81	5	77,9	42,0	47,3	28,7	24,5	25,7	59,4	41,3	61,9	41,3	61,9	82,7	40,0	16,7
81	6	93,4	50,4	56,8	34,5	29,3	30,8	71,3	49,6	74,3	49,6	74,3	99,3	48,0	20,1
81	7	109,0	58,8	66,2	40,2	34,2	36,0	83,2	57,8	86,7	57,8	86,7	115,8	56,0	23,4
81	8	124,6	67,2	75,7	46,0	39,1	41,1	95,1	66,1	99,1	66,1	99,1	132,3	64,0	26,8
81	9	140,2	75,6	85,1	51,7	44,0	46,3	107,0	74,3	111,5	74,3	111,5	148,9	72,1	30,1
81	10	155,7	84,0	94,6	57,4	48,9	51,4	118,9	82,6	123,9	82,6	123,9	165,4	80,1	33,5
82	4	63,9	34,5	38,8	23,6	20,1	21,0	48,7	33,9	50,8	33,9	50,8	67,9	32,8	13,7
82	5	79,9	43,1	48,5	29,5	25,1	26,2	60,9	42,4	63,5	42,4	63,5	84,8	41,1	17,2
82	6	95,8	51,7	58,2	35,4	30,1	31,5	73,1	50,8	76,2	50,8	76,2	101,8	49,3	20,6
82	7	111,8	60,3	67,9	41,2	35,1	36,7	85,2	59,3	88,9	59,3	88,9	118,8	57,5	24,0
82	8	127,8	68,9	77,6	47,1	40,1	42,0	97,4	67,8	101,7	67,8	101,7	135,7	65,7	27,4
82	9	143,7	77,5	87,3	53,0	45,1	47,2	109,6	76,2	114,4	76,2	114,4	152,7	73,9	30,9
82	10	159,7	86,1	97,0	58,9	50,2	52,5	121,8	84,7	127,1	84,7	127,1	169,7	82,1	34,3
83	4	65,5	35,3	39,8	24,2	20,6	21,4	49,8	34,7	52,1	34,7	52,1	69,6	33,7	14,1
83	5	81,8	44,1	49,7	30,2	25,7	26,8	62,3	43,4	65,1	43,4	65,1	86,9	42,1	17,6
83	6	98,2	53,0	59,7	36,2	30,8	32,1	74,8	52,1	78,1	52,1	78,1	104,3	50,5	21,1
83	7	114,6	61,8	69,6	42,3	36,0	37,5	87,2	60,8	91,2	60,8	91,2	121,7	58,9	24,6
83	8	131,0	70,6	79,5	48,3	41,1	42,8	99,7	69,5	104,2	69,5	104,2	139,1	67,3	28,1
83	9	147,3	79,4	89,5	54,3	46,3	48,2	112,2	78,1	117,2	78,1	117,2	156,5	75,7	31,6
83	10	163,7	88,3	99,4	60,4	51,4	53,5	124,6	86,8	130,2	86,8	130,2	173,9	84,2	35,2
84	4	67,1	36,2	40,7	24,7	21,1	21,8	51,0	35,6	53,4	35,6	53,4	71,2	34,5	14,4
84	5	83,8	45,2	50,9	30,9	26,3	27,3	63,7	44,5	66,7	44,5	66,7	89,1	43,1	18,0
84	6	100,6	54,3	61,1	37,1	31,6	32,8	76,5	53,4	80,0	53,4	80,0	106,9	51,7	21,6
84	7	117,4	63,3	71,3	43,3	36,9	38,2	89,2	62,3	93,4	62,3	93,4	124,7	60,3	25,2
84	8	134,1	72,3	81,5	49,5	42,1	43,7	102,0	71,1	106,7	71,1	106,7	142,5	69,0	28,8
84	9	150,9	81,4	91,7	55,7	47,4	49,1	114,7	80,0	120,1	80,0	120,1	160,3	77,6	32,4
84	10	167,7	90,4	101,8	61,9	52,7	54,6	127,5	88,9	133,4	88,9	133,4	178,1	86,2	36,0
85	4	68,7	37,0	41,7	25,3	21,6	22,3	52,1	36,4	54,6	36,4	54,6	72,9	35,3	14,8
85	5	85,8	46,3	52,1	31,7	27,0	27,8	65,2	45,5	68,3	45,5	68,3	91,2	44,1	18,4
85	6	103,0	55,5	62,6	38,0	32,3	33,4	78,2	54,6	81,9	54,6	81,9	109,4	52,9	22,1
85	7	120,2	64,8	73,0	44,3	37,7	39,0	91,2	63,7	95,6	63,7	95,6	127,6	61,8	25,8
85	8	137,3	74,1	83,4	50,7	43,1	44,5	104,3	72,8	109,3	72,8	109,3	145,9	70,6	29,5
85	9	154,5	83,3	93,8	57,0	48,5	50,1	117,3	81,9	122,9	81,9	122,9	164,1	79,4	33,2
85	10	171,7	92,6	104,3	63,3	53,9	55,7	130,3	91,0	136,6	91,0	136,6	182,3	88,2	36,9

ENGLISH

DAP values for CBCT exams

Patient gender	Patient size	Tube voltage [kV]	Tube current [mA]	Dental FOV 40x40		
				Standard [mGycm ²]	Medium [mGycm ²]	High [mGycm ²]
CHILD	SMALL	80	6	140,4	168,5	210,6
	MEDIUM	80	8	187,2	224,6	280,8
	LARGE	80	10	234,0	280,8	350,9
WOMAN	SMALL	85	6	165,4	198,5	248,2
	MEDIUM	85	8	220,6	264,7	330,9
	LARGE	85	10	275,7	330,9	413,6
MAN	SMALL	90	6	190,5	228,6	285,7
	MEDIUM	90	8	254,0	304,8	381,0
	LARGE	90	10	317,5	381,0	476,2

Patient gender	Patient size	Tube voltage [kV]	Tube current [mA]	Dental FOV 60x60		
				Standard [mGycm ²]	Medium [mGycm ²]	High [mGycm ²]
CHILD	SMALL	80	6	359,6	431,5	539,3
	MEDIUM	80	8	479,4	575,3	719,1
	LARGE	80	10	599,3	719,1	898,9
WOMAN	SMALL	85	6	424,3	509,2	636,5
	MEDIUM	85	8	565,7	678,9	848,6
	LARGE	85	10	707,2	848,6	1060,8
MAN	SMALL	90	6	489,1	586,9	733,6
	MEDIUM	90	8	652,1	782,5	978,1
	LARGE	90	10	815,1	978,1	1222,7

Patient gender	Patient size	Tube voltage [kV]	Tube current [mA]	Dental FOV 80x80 / 110x80		
				Standard [mGycm ²]	Medium [mGycm ²]	High [mGycm ²]
CHILD	SMALL	80	6	414,0	496,8	621,0
	MEDIUM	80	8	552,0	662,5	828,1
	LARGE	80	10	690,1	828,1	1035,1
WOMAN	SMALL	85	6	489,1	586,9	733,7
	MEDIUM	85	8	652,1	782,6	978,2
	LARGE	85	10	815,2	978,2	1222,8

ENGLISH

MAN	SMALL	90	6	564,2	677,0	846,3
	MEDIUM	90	8	752,2	902,7	1128,4
	LARGE	90	10	940,3	1128,4	1410,4

ENGLISH

DAP values for CEPH group exams

Tube voltage [kV]	Tube current [mA]	CEPH LL	CEPH LL Child	CEPH AP/PA	CEPH AP/PA Child	CARPUS
		[mGycm ²]				
60	4	9,9	8,2	12,1	9,7	8,0
60	5	12,4	10,2	15,1	12,1	10,0
60	6	14,9	12,3	18,1	14,5	12,0
60	7	17,4	14,3	21,1	16,9	14,0
60	8	19,9	16,4	24,2	19,4	16,0
60	9	22,4	18,4	27,2	21,8	18,0
60	10	24,9	20,5	30,2	24,2	20,0
61	4	10,3	8,5	12,6	10,1	8,3
61	5	12,9	10,6	15,8	12,6	10,4
61	6	15,4	12,7	18,9	15,1	12,4
61	7	18,0	14,8	22,1	17,6	14,5
61	8	20,6	16,9	25,2	20,1	16,6
61	9	23,2	19,1	28,4	22,7	18,7
61	10	25,7	21,2	31,6	25,2	20,7
62	4	10,7	8,7	13,2	10,5	8,6
62	5	13,3	10,9	16,5	13,1	10,8
62	6	16,0	13,1	19,7	15,7	12,9
62	7	18,6	15,3	23,0	18,3	15,1
62	8	21,3	17,5	26,3	20,9	17,2
62	9	24,0	19,7	29,6	23,5	19,4
62	10	26,6	21,9	32,9	26,1	21,5
63	4	11,0	9,0	13,7	10,8	8,9
63	5	13,8	11,3	17,1	13,5	11,1
63	6	16,5	13,5	20,6	16,3	13,4
63	7	19,3	15,8	24,0	19,0	15,6
63	8	22,0	18,0	27,4	21,7	17,8
63	9	24,8	20,3	30,8	24,4	20,1
63	10	27,5	22,6	34,3	27,1	22,3
64	4	11,4	9,3	14,3	11,2	9,2
64	5	14,2	11,6	17,8	14,0	11,5
64	6	17,0	13,9	21,4	16,8	13,8
64	7	19,9	16,3	24,9	19,6	16,1
64	8	22,7	18,6	28,5	22,4	18,4
64	9	25,6	20,9	32,1	25,2	20,7
64	10	28,4	23,2	35,6	28,1	23,0
65	4	11,7	9,6	14,8	11,6	9,5
65	5	14,6	12,0	18,5	14,5	11,9
65	6	17,6	14,4	22,2	17,4	14,3
65	7	20,5	16,8	25,9	20,3	16,7
65	8	23,4	19,1	29,6	23,2	19,0
65	9	26,4	21,5	33,3	26,1	21,4
65	10	29,3	23,9	37,0	29,0	23,8
66	4	12,1	9,8	15,3	12,0	9,8

ENGLISH

Tube voltage [kV]	Tube current [mA]	CEPH LL	CEPH LL Child	CEPH AP/PA	CEPH AP/PA Child	CARPUS
		[mGycm ²]				
66	5	15,1	12,3	19,2	15,0	12,3
66	6	18,1	14,8	23,0	18,0	14,7
66	7	21,1	17,2	26,8	21,0	17,2
66	8	24,1	19,7	30,7	24,0	19,7
66	9	27,1	22,2	34,5	27,0	22,1
66	10	30,2	24,6	38,4	30,0	24,6
67	4	12,4	10,1	15,9	12,4	10,1
67	5	15,5	12,7	19,9	15,5	12,7
67	6	18,6	15,2	23,8	18,6	15,2
67	7	21,7	17,7	27,8	21,7	17,7
67	8	24,8	20,2	31,8	24,7	20,3
67	9	27,9	22,8	35,7	27,8	22,8
67	10	31,0	25,3	39,7	30,9	25,3
68	4	12,8	10,4	16,4	12,8	10,4
68	5	16,0	13,0	20,5	15,9	13,1
68	6	19,2	15,6	24,6	19,1	15,7
68	7	22,4	18,2	28,8	22,3	18,3
68	8	25,5	20,8	32,9	25,5	20,9
68	9	28,7	23,4	37,0	28,7	23,5
68	10	31,9	26,0	41,1	31,9	26,1
69	4	13,1	10,7	17,0	13,1	10,7
69	5	16,4	13,3	21,2	16,4	13,4
69	6	19,7	16,0	25,5	19,7	16,1
69	7	23,0	18,7	29,7	23,0	18,8
69	8	26,3	21,4	33,9	26,3	21,5
69	9	29,5	24,0	38,2	29,6	24,2
69	10	32,8	26,7	42,4	32,9	26,9
70	4	13,5	11,0	17,5	13,5	11,1
70	5	16,8	13,7	21,9	16,9	13,8
70	6	20,2	16,4	26,3	20,3	16,6
70	7	23,6	19,2	30,7	23,7	19,3
70	8	27,0	21,9	35,0	27,1	22,1
70	9	30,3	24,6	39,4	30,4	24,9
70	10	33,7	27,4	43,8	33,8	27,6
71	4	13,8	11,2	18,1	13,9	11,4
71	5	17,3	14,0	22,6	17,4	14,2
71	6	20,7	16,8	27,1	20,9	17,0
71	7	24,2	19,6	31,6	24,3	19,9
71	8	27,7	22,5	36,1	27,8	22,7
71	9	31,1	25,3	40,6	31,3	25,6
71	10	34,6	28,1	45,2	34,8	28,4
72	4	14,2	11,5	18,6	14,3	11,7
72	5	17,7	14,4	23,3	17,9	14,6

ENGLISH

Tube voltage [kV]	Tube current [mA]	CEPH LL	CEPH LL Child	CEPH AP/PA	CEPH AP/PA Child	CARPUS
		[mGycm ²]				
72	6	21,3	17,3	27,9	21,4	17,5
72	7	24,8	20,1	32,6	25,0	20,4
72	8	28,4	23,0	37,2	28,6	23,3
72	9	31,9	25,9	41,9	32,2	26,3
72	10	35,5	28,8	46,5	35,7	29,2
73	4	14,5	11,8	19,1	14,7	12,0
73	5	18,2	14,7	23,9	18,4	15,0
73	6	21,8	17,7	28,7	22,0	18,0
73	7	25,4	20,6	33,5	25,7	21,0
73	8	29,1	23,6	38,3	29,4	24,0
73	9	32,7	26,5	43,1	33,0	26,9
73	10	36,3	29,4	47,9	36,7	29,9
74	4	14,9	12,1	19,7	15,1	12,3
74	5	18,6	15,1	24,6	18,8	15,4
74	6	22,3	18,1	29,5	22,6	18,4
74	7	26,1	21,1	34,5	26,4	21,5
74	8	29,8	24,1	39,4	30,1	24,6
74	9	33,5	27,1	44,3	33,9	27,6
74	10	37,2	30,1	49,2	37,7	30,7
75	4	15,2	12,3	20,2	15,5	12,6
75	5	19,1	15,4	25,3	19,3	15,7
75	6	22,9	18,5	30,4	23,2	18,9
75	7	26,7	21,6	35,4	27,0	22,0
75	8	30,5	24,7	40,5	30,9	25,2
75	9	34,3	27,7	45,5	34,8	28,3
75	10	38,1	30,8	50,6	38,6	31,5
76	4	15,6	12,6	20,8	15,8	12,9
76	5	19,5	15,8	26,0	19,8	16,1
76	6	23,4	18,9	31,2	23,8	19,3
76	7	27,3	22,1	36,4	27,7	22,6
76	8	31,2	25,2	41,6	31,7	25,8
76	9	35,1	28,4	46,8	35,6	29,0
76	10	39,0	31,5	52,0	39,6	32,2
77	4	16,0	12,9	21,3	16,2	13,2
77	5	19,9	16,1	26,7	20,3	16,5
77	6	23,9	19,3	32,0	24,3	19,8
77	7	27,9	22,5	37,3	28,4	23,1
77	8	31,9	25,8	42,7	32,4	26,4
77	9	35,9	29,0	48,0	36,5	29,7
77	10	39,9	32,2	53,3	40,5	33,0
78	4	16,3	13,2	21,9	16,6	13,5
78	5	20,4	16,4	27,3	20,8	16,9
78	6	24,5	19,7	32,8	24,9	20,3

ENGLISH

Tube voltage [kV]	Tube current [mA]	CEPH LL	CEPH LL Child	CEPH AP/PA	CEPH AP/PA Child	CARPUS
		[mGycm ²]				
78	7	28,5	23,0	38,3	29,1	23,6
78	8	32,6	26,3	43,7	33,2	27,0
78	9	36,7	29,6	49,2	37,4	30,4
78	10	40,8	32,9	54,7	41,5	33,8
79	4	16,7	13,4	22,4	17,0	13,8
79	5	20,8	16,8	28,0	21,2	17,3
79	6	25,0	20,2	33,6	25,5	20,7
79	7	29,2	23,5	39,2	29,7	24,2
79	8	33,3	26,9	44,8	34,0	27,6
79	9	37,5	30,2	50,4	38,2	31,1
79	10	41,6	33,6	56,0	42,5	34,5
80	4	17,0	13,7	23,0	17,4	14,1
80	5	21,3	17,1	28,7	21,7	17,7
80	6	25,5	20,6	34,4	26,1	21,2
80	7	29,8	24,0	40,2	30,4	24,7
80	8	34,0	27,4	45,9	34,7	28,2
80	9	38,3	30,8	51,7	39,1	31,8
80	10	42,5	34,3	57,4	43,4	35,3
81	4	17,4	14,0	23,5	17,8	14,4
81	5	21,7	17,5	29,4	22,2	18,0
81	6	26,0	21,0	35,3	26,6	21,6
81	7	30,4	24,5	41,1	31,1	25,2
81	8	34,7	28,0	47,0	35,5	28,9
81	9	39,1	31,5	52,9	40,0	32,5
81	10	43,4	35,0	58,8	44,4	36,1
82	4	17,7	14,3	24,0	18,1	14,7
82	5	22,1	17,8	30,1	22,7	18,4
82	6	26,6	21,4	36,1	27,2	22,1
82	7	31,0	25,0	42,1	31,7	25,8
82	8	35,4	28,5	48,1	36,3	29,5
82	9	39,9	32,1	54,1	40,8	33,1
82	10	44,3	35,7	60,1	45,4	36,8
83	4	18,1	14,5	24,6	18,5	15,0
83	5	22,6	18,2	30,7	23,2	18,8
83	6	27,1	21,8	36,9	27,8	22,6
83	7	31,6	25,4	43,0	32,4	26,3
83	8	36,1	29,1	49,2	37,1	30,1
83	9	40,7	32,7	55,3	41,7	33,8
83	10	45,2	36,3	61,5	46,3	37,6
84	4	18,4	14,8	25,1	18,9	15,3
84	5	23,0	18,5	31,4	23,6	19,2
84	6	27,6	22,2	37,7	28,4	23,0
84	7	32,2	25,9	44,0	33,1	26,9

ENGLISH

Tube voltage [kV]	Tube current [mA]	CEPH LL	CEPH LL Child	CEPH AP/PA	CEPH AP/PA Child	CARPUS
		[mGycm ²]				
84	8	36,8	29,6	50,3	37,8	30,7
84	9	41,5	33,3	56,5	42,6	34,5
84	10	46,1	37,0	62,8	47,3	38,4
85	4	18,8	15,1	25,7	19,3	15,7
85	5	23,5	18,9	32,1	24,1	19,6
85	6	28,2	22,6	38,5	28,9	23,5
85	7	32,9	26,4	44,9	33,8	27,4
85	8	37,6	30,2	51,4	38,6	31,3
85	9	42,2	34,0	57,8	43,4	35,2
85	10	46,9	37,7	64,2	48,2	39,1

11.16.2 DOSIMETRIC INDICATIONS IN TERMS OF CTDI (FOR CBCT EXAMS)

The following tables provide dosimetric indications related to the execution of CBCT exams using X-MIND trium.





The radiation dose is reported in terms of Computed Tomography Dose Index (CTDI), which represents the integral of dose profile along a line perpendicular to the tomographic plane divided by the product of the nominal tomographic section thickness and the number of tomograms produced in a single scan.

CTDI values were measured setting the following loading factors and without the application of any filter:

Patient gender	Patient size	Tube Voltage [kV]	Anodic Current [mA]
Man	Small	90	6
	Medium	90	8
	Large	90	10
Woman	Small	85	6
	Medium	85	8
	Large	85	10
Child	Small	80	6
	Medium	80	8
	Large	80	10

The dosimetry phantom used to perform the test is the QUART DVT_AP. All dose measurements were performed with the CT dosimetry phantom placed on a support device, without additional attenuating materials present.

The following table reports the CTDI values measured at the indicated locations in the dosimetry phantom, with the typical settings suggested for a CBCT exam using X-MIND trium (e.g. Man Medium, FOV 40x40):

Location	CTDI [mGy]
 <p>Along the axis of rotation</p>	2,86
 <p>Along a line parallel to the axis of rotation and 1.0 cm interior to the surface of the phantom</p>	1.25
 <p>Along a line parallel to the axis of rotation and 1.0 centimeter interior to the surface of the phantom at position 90 degrees from the position b)</p>	1.12
 <p>Along a line parallel to the axis of rotation and 1.0 centimeter interior to the surface of the phantom at position 180 degrees from the position b)</p>	1.17

ENGLISH

	Along a line parallel to the axis of rotation and 1.0 centimeter interior to the surface of the phantom at position 270 degrees from the position b)	1.19
---	--	------

In the following tables the CTDI values measured in the central location of the dosimetry phantom in each selectable CBCT condition of operation are listed. Three tables are reported, each referred to a different patient selection: man, woman, child. Please note that CTDI values are presented both as absolute value (CTDI [mGycm] column) and as relative value (CTDI normalized), which correspond to the absolute value normalized to the CTDI in the center location of the dosimetry phantom.

Patient selection: man

FOV	Size	Quality	Tube Voltage [kV]	Anodic Current [mA]	Exposure Duration [s]	Current Time Product [mAs]	CTDI [mGy]	CTDI normalized
40 x 40 mm	Small	Standard	90	6.0	6.0	36.0	1.75	0.60
	Medium	Standard	90	8.0	6.0	48.0	2.42	0.85
	Large	Standard	90	10.0	6.0	60.0	3.00	1.05
	Small	Medium	90	6.0	7.2	43.2	2.16	0.76
	Medium	Medium	90	8.0	7.2	57.6	2.86	1.00
	Large	Medium	90	10.0	7.2	72.0	3.55	1.24
	Small	High	90	6.0	9.0	54.0	2.69	0.94
	Medium	High	90	8.0	9.0	72.0	3.57	1.25
	Large	High	90	10.0	9.0	90.0	4.47	1.57
60 x 60 mm	Small	Standard	90	6.0	6.0	36.0	2.88	1.01
	Medium	Standard	90	8.0	6.0	48.0	3.85	1.35
	Large	Standard	90	10.0	6.0	60.0	4.80	1.68
	Small	Medium	90	6.0	7.2	43.2	3.49	1.22
	Medium	Medium	90	8.0	7.2	57.6	4.60	1.61
	Large	Medium	90	10.0	7.2	72.0	5.78	2.02
	Small	High	90	6.0	9.0	54.0	4.31	1.51
	Medium	High	90	8.0	9.0	72.0	5.78	2.02
	Large	High	90	10.0	9.0	90.0	7.21	2.52
80 x 80 mm	Small	Standard	90	6.0	6.0	36.0	3.24	1.13
	Medium	Standard	90	8.0	6.0	48.0	4.17	1.46
	Large	Standard	90	10.0	6.0	60.0	5.33	1.87
	Small	Medium	90	6.0	7.2	43.2	3.79	1.33
	Medium	Medium	90	8.0	7.2	57.6	5.11	1.79
	Large	Medium	90	10.0	7.2	72.0	6.36	2.23
	Small	High	90	6.0	9.0	54.0	4.77	1.67
	Medium	High	90	8.0	9.0	72.0	6.36	2.23
	Large	High	90	10.0	9.0	90.0	7.93	2.78

ENGLISH

110 x 80 mm	Small	Standard	90	6.0	6.0	36.0	3.15	1.10
	Medium	Standard	90	8.0	6.0	48.0	4.14	1.45
	Large	Standard	90	10.0	6.0	60.0	5.18	1.81
	Small	Medium	90	6.0	7.2	43.2	3.77	1.32
	Medium	Medium	90	8.0	7.2	57.6	5.01	1.75
	Large	Medium	90	10.0	7.2	72.0	6.28	2.20
	Small	High	90	6.0	9.0	54.0	4.71	1.65
	Medium	High	90	8.0	9.0	72.0	6.28	2.20
	Large	High	90	10.0	9.0	90.0	7.82	2.74

Patient selection: woman

FOV	Size	Quality	Tube Voltage [kV]	Anodic Current [mA]	Exposure Duration [s]	Current Time Product [mAs]	CTDI [mGy]	CTDI normalized
40 x 40 mm	Small	Standard	85	6.0	6.0	36.0	1.44	0.51
	Medium	Standard	85	8.0	6.0	48.0	2.00	0.70
	Large	Standard	85	10.0	6.0	60.0	2.49	0.87
	Small	Medium	85	6.0	7.2	43.2	1.79	0.63
	Medium	Medium	85	8.0	7.2	57.6	2.39	0.84
	Large	Medium	85	10.0	7.2	72.0	2.94	1.03
	Small	High	85	6.0	9.0	54.0	2.21	0.77
	Medium	High	85	8.0	9.0	72.0	3.00	1.05
	Large	High	85	10.0	9.0	90.0	3.72	1.30
60 x 60 mm	Small	Standard	85	6.0	6.0	36.0	2.37	0.83
	Medium	Standard	85	8.0	6.0	48.0	3.14	1.10
	Large	Standard	85	10.0	6.0	60.0	3.94	1.38
	Small	Medium	85	6.0	7.2	43.2	2.88	1.01
	Medium	Medium	85	8.0	7.2	57.6	3.80	1.33
	Large	Medium	85	10.0	7.2	72.0	4.76	1.67
	Small	High	85	6.0	9.0	54.0	3.51	1.23
	Medium	High	85	8.0	9.0	72.0	4.79	1.68
	Large	High	85	10.0	9.0	90.0	5.98	2.09
80 x 80 mm	Small	Standard	85	6.0	6.0	36.0	2.64	0.93
	Medium	Standard	85	8.0	6.0	48.0	3.48	1.22
	Large	Standard	85	10.0	6.0	60.0	4.36	1.53
	Small	Medium	85	6.0	7.2	43.2	3.16	1.10
	Medium	Medium	85	8.0	7.2	57.6	4.19	1.47
	Large	Medium	85	10.0	7.2	72.0	5.23	1.83
	Small	High	85	6.0	9.0	54.0	3.95	1.38
	Medium	High	85	8.0	9.0	72.0	5.25	1.84
	Large	High	85	10.0	9.0	90.0	6.56	2.30
110 x 80 mm	Small	Standard	85	6.0	6.0	36.0	2.59	0.91
	Medium	Standard	85	8.0	6.0	48.0	3.52	1.23
	Large	Standard	85	10.0	6.0	60.0	4.34	1.52
	Small	Medium	85	6.0	7.2	43.2	3.08	1.08
	Medium	Medium	85	8.0	7.2	57.6	4.21	1.47
	Large	Medium	85	10.0	7.2	72.0	5.29	1.85
	Small	High	85	6.0	9.0	54.0	3.96	1.38
	Medium	High	85	8.0	9.0	72.0	5.20	1.82
	Large	High	85	10.0	9.0	90.0	6.53	2.29

ENGLISH

Patient selection: child

FOV	Size	Quality	Tube Voltage [kV]	Anodic Current [mA]	Exposure Duration [s]	Current Time Product [mAs]	CTDI [mGy]	CTDI normalized
40 x 40 mm	Small	Standard	80	6.0	6.0	36.0	1.17	0.59
	Medium	Standard	80	8.0	6.0	48.0	1.59	0.80
	Large	Standard	80	10.0	6.0	60.0	1.94	0.97
	Small	Medium	80	6.0	7.2	43.2	1.51	0.76
	Medium	Medium	80	8.0	7.2	57.6	1.99	1.00
	Large	Medium	80	10.0	7.2	72.0	2.50	1.26
	Small	High	80	6.0	9.0	54.0	1.85	0.93
	Medium	High	80	8.0	9.0	72.0	2.55	0.41
	Large	High	80	10.0	9.0	90.0	3.08	0.56
60 x 60 mm	Small	Standard	80	6.0	6.0	36.0	1.99	0.68
	Medium	Standard	80	8.0	6.0	48.0	2.69	0.53
	Large	Standard	80	10.0	6.0	60.0	3.27	0.70
	Small	Medium	80	6.0	7.2	43.2	2.41	0.88
	Medium	Medium	80	8.0	7.2	57.6	3.18	0.65
	Large	Medium	80	10.0	7.2	72.0	3.91	0.89
	Small	High	80	6.0	9.0	54.0	2.91	1.08
	Medium	High	80	8.0	9.0	72.0	3.99	0.70
	Large	High	80	10.0	9.0	90.0	4.99	0.94
80 x 80 mm	Small	Standard	80	6.0	6.0	36.0	2.22	1.14
	Medium	Standard	80	8.0	6.0	48.0	2.90	0.85
	Large	Standard	80	10.0	6.0	60.0	3.64	1.11
	Small	Medium	80	6.0	7.2	43.2	2.51	1.37
	Medium	Medium	80	8.0	7.2	57.6	3.47	1.02
	Large	Medium	80	10.0	7.2	72.0	4.31	1.40
	Small	High	80	6.0	9.0	54.0	3.29	1.75
	Medium	High	80	8.0	9.0	72.0	4.26	0.78
	Large	High	80	10.0	9.0	90.0	5.38	1.01
110 x 80 mm	Small	Standard	80	6.0	6.0	36.0	2.19	1.27
	Medium	Standard	80	8.0	6.0	48.0	2.93	0.88
	Large	Standard	80	10.0	6.0	60.0	3.64	1.21
	Small	Medium	80	6.0	7.2	43.2	2.59	1.51
	Medium	Medium	80	8.0	7.2	57.6	3.47	1.15
	Large	Medium	80	10.0	7.2	72.0	4.40	1.49
	Small	High	80	6.0	9.0	54.0	3.26	1.88
	Medium	High	80	8.0	9.0	72.0	4.36	0.77
	Large	High	80	10.0	9.0	90.0	5.41	1.03

ENGLISH

In the following tables the CTDI values measured in one of the four locations at 1 centimeter from the phantom surface in each selectable CBCT condition of operation are listed. Three tables are reported, each referred to a different patient selection: man, woman, child. Please note that CTDI values are presented both as absolute value (CTDI [mGy] column) and as relative value (CTDI normalized), which correspond to the absolute value normalized to the CTDI in the center location of the dosimetry phantom.

Patient selection: man

FOV	Size	Quality	Tube Voltage [kV]	Anodic Current [mA]	Exposure Duration [s]	Current Time Product [mAs]	CTDI [mGy]	CTDI normalized
40 x 40 mm	Small	Standard	90	6.0	6.0	36.0	0.74	0.66
	Medium	Standard	90	8.0	6.0	48.0	0.94	0.84
	Large	Standard	90	10.0	6.0	60.0	1.24	1.10
	Small	Medium	90	6.0	7.2	43.2	0.74	0.66
	Medium	Medium	90	8.0	7.2	57.6	1.12	1.00
	Large	Medium	90	10.0	7.2	72.0	1.41	1.26
	Small	High	90	6.0	9.0	54.0	1.07	0.96
	Medium	High	90	8.0	9.0	72.0	1.38	1.23
	Large	High	90	10.0	9.0	90.0	1.54	1.37
60 x 60 mm	Small	Standard	90	6.0	6.0	36.0	1.82	1.62
	Medium	Standard	90	8.0	6.0	48.0	2.53	2.25
	Large	Standard	90	10.0	6.0	60.0	3.03	2.70
	Small	Medium	90	6.0	7.2	43.2	2.21	1.97
	Medium	Medium	90	8.0	7.2	57.6	2.93	2.61
	Large	Medium	90	10.0	7.2	72.0	3.70	3.30
	Small	High	90	6.0	9.0	54.0	2.80	2.49
	Medium	High	90	8.0	9.0	72.0	3.54	3.15
	Large	High	90	10.0	9.0	90.0	4.64	4.13
80 x 80 mm	Small	Standard	90	6.0	6.0	36.0	2.30	2.04
	Medium	Standard	90	8.0	6.0	48.0	3.06	2.72
	Large	Standard	90	10.0	6.0	60.0	3.56	3.17
	Small	Medium	90	6.0	7.2	43.2	2.81	2.51
	Medium	Medium	90	8.0	7.2	57.6	3.64	3.24
	Large	Medium	90	10.0	7.2	72.0	4.53	4.04
	Small	High	90	6.0	9.0	54.0	3.39	3.02
	Medium	High	90	8.0	9.0	72.0	4.49	4.00
	Large	High	90	10.0	9.0	90.0	5.64	5.02

ENGLISH

110 x 80 mm	Small	Standard	90	6.0	6.0	36.0	2.59	2.31
	Medium	Standard	90	8.0	6.0	48.0	3.43	3.06
	Large	Standard	90	10.0	6.0	60.0	4.22	3.76
	Small	Medium	90	6.0	7.2	43.2	3.12	2.78
	Medium	Medium	90	8.0	7.2	57.6	4.04	3.60
	Large	Medium	90	10.0	7.2	72.0	5.06	4.51
	Small	High	90	6.0	9.0	54.0	3.80	3.38
	Medium	High	90	8.0	9.0	72.0	5.03	4.49
	Large	High	90	10.0	9.0	90.0	6.19	5.52

Patient selection: woman

FOV	Size	Quality	Tube Voltage [kV]	Anodic Current [mA]	Exposure Duration [s]	Current Time Product [mAs]	CTDI [mGy]	CTDI normalized
40 x 40 mm	Small	Standard	85	6.0	6.0	36.0	0.60	0.53
	Medium	Standard	85	8.0	6.0	48.0	0.85	0.76
	Large	Standard	85	10.0	6.0	60.0	0.87	0.78
	Small	Medium	85	6.0	7.2	43.2	0.71	0.63
	Medium	Medium	85	8.0	7.2	57.6	0.90	0.80
	Large	Medium	85	10.0	7.2	72.0	1.11	0.99
	Small	High	85	6.0	9.0	54.0	0.69	0.62
	Medium	High	85	8.0	9.0	72.0	1.09	0.97
	Large	High	85	10.0	9.0	90.0	1.36	1.21
60 x 60 mm	Small	Standard	85	6.0	6.0	36.0	1.41	1.26
	Medium	Standard	85	8.0	6.0	48.0	2.19	1.95
	Large	Standard	85	10.0	6.0	60.0	2.64	2.35
	Small	Medium	85	6.0	7.2	43.2	1.97	1.75
	Medium	Medium	85	8.0	7.2	57.6	2.48	2.21
	Large	Medium	85	10.0	7.2	72.0	3.05	2.72
	Small	High	85	6.0	9.0	54.0	2.27	2.03
	Medium	High	85	8.0	9.0	72.0	2.80	2.50
	Large	High	85	10.0	9.0	90.0	3.82	3.41

ENGLISH

80 x 80 mm	Small	Standard	85	6.0	6.0	36.0	1.88	1.67
	Medium	Standard	85	8.0	6.0	48.0	2.45	2.18
	Large	Standard	85	10.0	6.0	60.0	3.04	2.70
	Small	Medium	85	6.0	7.2	43.2	2.10	1.87
	Medium	Medium	85	8.0	7.2	57.6	2.81	2.50
	Large	Medium	85	10.0	7.2	72.0	3.59	3.20
	Small	High	85	6.0	9.0	54.0	2.65	2.36
	Medium	High	85	8.0	9.0	72.0	3.54	3.16
	Large	High	85	10.0	9.0	90.0	4.33	3.85
110 x 80 mm	Small	Standard	85	6.0	6.0	36.0	1.97	1.76
	Medium	Standard	85	8.0	6.0	48.0	2.88	2.56
	Large	Standard	85	10.0	6.0	60.0	3.46	3.08
	Small	Medium	85	6.0	7.2	43.2	2.37	2.11
	Medium	Medium	85	8.0	7.2	57.6	3.30	2.94
	Large	Medium	85	10.0	7.2	72.0	4.21	3.75
	Small	High	85	6.0	9.0	54.0	3.24	2.89
	Medium	High	85	8.0	9.0	72.0	4.07	3.63
	Large	High	85	10.0	9.0	90.0	4.89	4.36

Patient selection: child

FOV	Size	Quality	Tube Voltage [kV]	Anodic Current [mA]	Exposure Duration [s]	Current Time Product [mAs]	CTDI [mGy]	CTDI normalized
40 x 40 mm	Small	Standard	80	6.0	6.0	36.0	0.49	0.44
	Medium	Standard	80	8.0	6.0	48.0	0.74	0.66
	Large	Standard	80	10.0	6.0	60.0	0.81	0.72
	Small	Medium	80	6.0	7.2	43.2	0.65	0.58
	Medium	Medium	80	8.0	7.2	57.6	0.82	0.73
	Large	Medium	80	10.0	7.2	72.0	1.13	1.01
	Small	High	80	6.0	9.0	54.0	0.58	0.51
	Medium	High	80	8.0	9.0	72.0	1.07	0.95
	Large	High	80	10.0	9.0	80.0	1.26	1.12

ENGLISH

60 x 60 mm	Small	Standard	80	6.0	6.0	36.0	1.18	1.05
	Medium	Standard	80	8.0	6.0	48.0	1.58	1.40
	Large	Standard	80	10.0	6.0	60.0	1.90	1.69
	Small	Medium	80	6.0	7.2	43.2	1.47	1.31
	Medium	Medium	80	8.0	7.2	57.6	1.95	1.74
	Large	Medium	80	10.0	7.2	72.0	2.45	2.18
	Small	High	80	6.0	9.0	54.0	1.80	1.60
	Medium	High	80	8.0	9.0	72.0	2.50	2.23
	Large	High	80	10.0	9.0	80.0	3.09	2.75
80 x 80 mm	Small	Standard	80	6.0	6.0	36.0	1.26	1.13
	Medium	Standard	80	8.0	6.0	48.0	2.05	1.82
	Large	Standard	80	10.0	6.0	60.0	2.42	2.15
	Small	Medium	80	6.0	7.2	43.2	1.80	1.60
	Medium	Medium	80	8.0	7.2	57.6	2.35	2.10
	Large	Medium	80	10.0	7.2	72.0	3.03	2.70
	Small	High	80	6.0	9.0	54.0	2.15	1.91
	Medium	High	80	8.0	9.0	72.0	2.96	2.63
	Large	High	80	10.0	9.0	80.0	3.72	3.32
110 x 80 mm	Small	Standard	80	6.0	6.0	36.0	1.78	1.59
	Medium	Standard	80	8.0	6.0	48.0	2.39	2.13
	Large	Standard	80	10.0	6.0	60.0	2.82	2.51
	Small	Medium	80	6.0	7.2	43.2	2.13	1.90
	Medium	Medium	80	8.0	7.2	57.6	2.71	2.42
	Large	Medium	80	10.0	7.2	72.0	3.41	3.04
	Small	High	80	6.0	9.0	54.0	2.41	2.15
	Medium	High	80	8.0	9.0	72.0	3.37	3.00
	Large	High	80	10.0	9.0	80.0	5.42	3.75

The following tables report the standard deviation, respectively, for peripheral and central positions in the dosimetry phantom:

	STANDARD DEVIATION [mGy]
MAN	0.64
WOMAN	1.01
CHILD	0.73

	STANDARD DEVIATION [mGy]
MAN	0.25
WOMAN	0.26
CHILD	0.47

11.17 ELECTROMAGNETIC COMPATIBILITY

All the information below is based on the requirements of standards to which the manufacturers of electrical medical devices must adhere (as stated in standard IEC60601-1-2).

The medical device complies with the electromagnetic compatibility standards in force. However, the user will make sure that any electromagnetic interference does not create an additional risk, such as radiofrequency transmitters, or other electronic devices.

This chapter contains the information required for you to install and use your medical device in optimum conditions in terms of electromagnetic compatibility.

Some types of mobile telecommunication devices, such as mobile phones, may interfere with the medical device. The separation distances recommended in this chapter **MUST** be respected.

The medical device must not be used near another device or placed on top of it. If this cannot be avoided, correct operation of the device in operating conditions must be checked prior to use.

The use of accessories other than those specified or sold by ACTEON® Imaging as replacement parts, may increase the transmission or reduce the immunity of the medical device.

11.17.1 RECOMMENDED SEPARATION DISTANCES

The medical device is designed to be used in an electromagnetic environment in which interferences caused by RF radiation are controlled.

The user or installer of the medical device may help to prevent electromagnetic interference by maintaining a minimum distance, depending on the maximum power of the handheld and mobile radiofrequency transmission equipment (transmitters), between the medical device and the equipment as recommended in the table below.

Rated maximum output power of the transmitter [W]	Separation distance according to transmitter frequency [m]		
	150 kHz - 80 MHz $d = 1,2 \sqrt{P}$	80 MHz - 800 MHz $d = 1,2 \sqrt{P}$	800 MHz - 2.5 GHz $d = 2,3 \sqrt{P}$
0.01	0.12	0.12	0.24
0.1	0.38	0.38	0.73
1	1,2	1.2	2.3
10	3,8	3.8	7.3
100	12	12	23

In the event of transmitters whose maximum nominal output power coefficient does not fall within the indicated parameters, the recommended separation distance in metres (m) can be determined by means of the equation corresponding to the frequency of the transmitter, where (P) is the maximum output power coefficient of the transmitter in watts (W) according to the information provided by the manufacturer.

Note 1: At 80 MHz and 800 MHz apply the separation distance corresponding to the highest frequency range.

Note 2: These guidelines may not apply in every situation. Electromagnetic propagation is affected by absorption and reflection from structures, objects and people.

The electromagnetic propagation is affected by absorption and reflection from structures, objects and people.

11.17.2 ELECTROMAGNETIC EMISSIONS

The medical device is designed for use in the electromagnetic environment described in the table below. The user and/or installer must ensure that the medical device is used in the environment described below.

ENGLISH

Emission test	Conformity	Electromagnetic environment guidance
RF emissions CISPR 11	Group 1	The medical device uses RF energy only for internal operation. RF emissions are extremely reduced and are not likely to generate interference with electronic equipment in the vicinity.
RF emissions CISPR 11	Class A	The medical device is suitable for use in all establishments other than domestic establishments and those directly connected to the public low-voltage power supply network that supplies buildings used for domestic purposes.
Harmonic emissions IEC 61000-3-2	Class A	
Voltage fluctuations/flicker emissions IEC 61000-3-3	Complies	

11.17.3 ELECTROMAGNETIC IMMUNITY

The medical device is designed for use in the magnetic and electromagnetic environment described in the table below. The user and/or installer must ensure conformity of the electromagnetic environment.

Immunity test	CEI EN 60601 test level	Compliance level	Electromagnetic environment guidance
Electrostatic discharge (ESD) IEC 61000-4-2	+/- 6 kV contact +/- 8 kV air	IEC 60601-1-2 Test level	Floors should be wood, concrete or ceramic tile. If floors are covered with synthetic material, the relative humidity must be at least 30%
Electrical fast transient/burst IEC 61000-4-4	+/- 2 kV for power supply lines +/- 1 kV for input/output lines	IEC 60601-1-2 Test level	Mains power quality should conform to that of typical commercial or hospital applications.
Surge IEC 61000-4-5	+/- 1 kV differential mode +/- 2 kV common mode	IEC 60601-1-2 Test level	Mains power quality should conform to that of typical commercial or hospital applications.
Voltage dips, short interruptions and voltage variations on power supply input lines IEC 61000-4-11	<5 % UT for 0.5 cycles (>95 % dip in UT) 40 % UT for 5 cycles (60 % dip in UT) 70 % UT for 25 cycles (30 % dip in UT) <5 % UT for 5 onds (>95 % dip in UT)	IEC 60601-1-2 Test level	Mains power quality should conform to that of typical commercial or hospital applications. If the operator requires continued operation even during mains power outage, we recommend powering the system using a UPS.
Mains frequency (50/60 Hz) magnetic field IEC 61000-4-8	3 A/m	IEC 60601-1-2 Test level	Power frequency magnetic fields must be at the typical level of standard mains for commercial or hospital use.

Note: Ut is the AC mains voltage prior to the application of the test level.

ENGLISH

11.17.4 ELECTROMAGNETIC IMMUNITY, HANDHELD RADIOFREQUENCY EQUIPMENT

The medical device is designed for use in the magnetic and electromagnetic environment described in the table below. The user and/or installer must ensure conformity of the electromagnetic environment.

Immunity test	CEI EN 60601 test level	Compliance level	Electromagnetic environment guidance
Handheld and mobile RF communication equipment must be used no closer to any part of the medical device, including cables than the recommended separation distance, calculated according to the equation corresponding to the frequency of the transmitter.			
Conducted RF IEC 61000-4-6	3 Vrms 150 kHz to 80 MHz	3 Vrms	Recommended separation distance $d = 1,2 \sqrt{P}$
Radiated RF IEC 61000-4-3	10 V/m 80MHz to 2.5GHz	3 V/m	$d = 1,2 \sqrt{P}$ 80 MHz - 800 MHz $d = 2,3 \sqrt{P}$ 800 MHz - 2.5 GHz Where P is the maximum output power rating of the transmitter in watts (W) according to the transmitter manufacturer and "d" is the recommended separation distance in meters (m).
Field strength from fixed RF transmitters as determined by an electromagnetic site survey ^a must be below the compliance level corresponding to each frequency range. ^b Interference can occur in the proximity of equipment marked with the following symbol: 			

Note 1: At 80 MHz and 800 MHz the higher frequency range applies.

Note 2: These guidelines may not apply in every situation. Electromagnetic propagation is affected by absorption and reflection from structures, objects and people.

(a) Field strength from fixed RF transmitters, such as base stations for radio (cellular/wireless) telephones and land mobile radios, amateur radio, AM and FM radio and TV broadcast cannot be predicted with accuracy on a theoretical basis. To assess the electromagnetic environment created by fixed RF transmitters, an electromagnetic site survey should be considered. If the measured field strength in the place where the equipment is used exceeds the corresponding RF compliance level (see above), it is important to ensure regular equipment operation. In the event of abnormal operation, additional measures may be required, such as redirecting or relocating the product.

(b) Over the frequency range between 150 kHz and 80 MHz, the field strength must be below 10

WARNINGS

12.1 FEDERAL LAW

The indication below applies to the United States of America only.

The United States Federal Law restricts the use of this medical device in its territory to qualified dental health professionals, fit and certified to perform and manage their professional duties.

For the U.S. market: federal laws restrict these devices to sale by or on the order of a specialized surgeons, dentists and authorized personnel, who meet the requirements provided by the national laws in force in the country of installation.

12.2 WARNING APPLICABLE TO ALL COUNTRIES IN WHICH THE DEVICE IS SOLD

The information below is based on the requirements of standards to which the manufacturers of medical devices must adhere (as stated in the standard IEC 62366).

12.3 USER POPULATION

This radiological medical device must only be used by qualified dental health practitioners, fit and certified to perform their professional duties. The user must be authorised and duly trained (see Section 4.4 Specific user training), according to the requirements provided by the national laws in force in the country of installation. The training and preparation of personnel are included in the tasks of RESPONSIBLE ORGANIZATION.

Users must know and comply with the rules of dental practice in compliance with knowledge acquired in the field and the key medical hygiene principles including cleaning, disinfection and sterilization of medical devices.

The medical device can be used by any adult dental practitioner of any weight, height, gender and nationality.

The user must wear gloves.

The user is not the patient.

The user must not be prone to any of the following:

- visual impairments: any vision problems must be corrected by glasses or lenses.
- hearing difficulties that could prevent the user hearing audible alarms depending on medical devices;
- difficulty memorizing or concentrating that could affect the setting of sequences or the performance of acquisition protocols.

12.4 SPECIFIC USER TRAINING

THE INDICATION BELOW APPLIES TO THE ONTARIO ONLY:

The Standard of practice for CT dental scanners approved by Council – April 18, 2011 prescribes specific professional requirements for the use of CT dental scanners with respect to the FOV generated

INFORMATION APPLICABLE TO ALL THE COUNTRIES WHERE THE DEVICE IS SOLD:

ACTEON Imaging, upon request, provides Training and/or materials for training on the basis of the specific needs identified by RESPONSIBLE ORGANIZATION.

Contents, duration, options and details of the training courses are detailed in the purchasing contract, for information you must ask to your dealer / distributor.

12.5 PATIENT POPULATION

This medical device is designed to be used with the following patient population:

- Children from 5 years old [~21 kg (46 lb); 113 cm (44.5 in) standing height],
- Teenagers,
- Adults,
- Old Age Pensioners.

This medical device can be used on any patient of any weight, age, height (except the restrictions indicated for children), gender and nationality.

12.6 PATIENT POPULATION RESTRICTION

This medical device must not be used on the following patient population:

- Infants,
- pregnant women
- Before exposing patients with pacemakers, contact the manufacturer of the latter to ensure that the X-rays generated by the medical device do not interfere with its functionality

The user is the only person who can decide whether or not to make the radiologic acquisition with his/her patients.

12.7 PARTS OF THE BODY OR TYPES OF TISSUES FOR DIAGNOSIS

The medical device has been designed to acquire digital radiography images and reconstruct tomographic images of the dental maxillofacial and otolaryngological regions.

12.8 ESSENTIAL PERFORMANCE

ACTEON Imaging considered the essential performances, as stated in the applicable safety standard pertaining to the electrical medical device, in the Risk Management Process.

12.9 NORMAL USAGE CONDITIONS

The normal usage conditions are as follows:

- Storage;
- Installation;
- Use;
- Maintenance;
- Disposal.

12.10 X-RAY PROTECTION



This symbol draws the ATTENTION to X-ray hazards:

The medical device is a device that generates X-rays; therefore, both the patients and the operator are exposed to risks due to ionising radiation.

Installation

The medical device must be shielded and used in compliance with the local standards in force and with the international directives concerning radiation protection for the operator, patient and other people against X-rays.

Operator

The operator and other subjects must keep clear from the patient during the scan.

The personnel involved in the radiographic examination must take all the safety measures concerning radiation protection.

Patient

The «General principles for safeguarding and protecting the personnel and patients» must always be applied during the use of the X-ray unit.

- Justification of the practice
- Optimisation of protection principle (ALARA principle)
- Individual risk and dose limits

It is the operator's responsibility to protect the patient against unnecessary or excessive radiation doses.

Additional protection devices (aprons, collars, etc.) are required to protect the patient from radiation.

12.11 MECHANICAL SAFETY

Improper installation of the medical device can expose the operator and patients to fall and crushing hazards. Prevent situations that can compromise the stability of the medical device, such as:

- Changing its installation layout,
- Moving the device,
- Operate changes in the supporting wall structure.

12.12 ELECTRICAL SAFETY

The operator must not inspect internal parts or disassemble any part of the device and of the workstation. The unit must be installed solely in environments that meet safety standards and laws concerning premises used for medical purposes.

The unit is not equipped with protective devices against penetration of liquids; therefore it is essential to ensure that no water or other liquids can penetrate inside to prevent short circuits or corrosion. Always disconnect the system from the power supply and the workstation before cleaning and disinfecting it. Do not tread on the ETHERNET or on the CONTROL cable. Any damage to the conductors or connectors of these cables can compromise the proper operation of the device, its communication circuits and the Workstation.

The installation of the equipment must be permanent (fixed) in compliance with the IEC 60601-1 standard. It is PROHIBITED to plug the device to the power supply.

Don't connect the device to the mains before ensuring the correct power supply voltage, as indicated in the identification plate. Incorrect voltage can cause irreversible damage to the electronic components of the medical device.

The electrical system where the device is installed must be suitably earthed, in compliance with NEC and IEC standards and with the laws in force in the country of installation.

For Italy: The electrical system where the device is installed must be made in a workmanlike manner and in compliance with the IEC 64-8 standard with reference to premises used for medical purposes.

12.13 POSITIONING LASERS

	<p>X-MIND trium is a class 3R laser product. Avoid direct eye exposure to laser radiation. Viewing the laser output with telescopic optical instruments (for example, telescopes and binoculars) may pose an eye hazard and thus the user should not direct the beam into an area where such instruments are likely to be used</p> <p>Use of controls or adjustments or performance of procedures other than those specified herein may result in hazardous radiation exposure</p>
---	---

12.14 PATIENT DATA

Storage and Backups

The operator is responsible for the storage and backup of the data provided by the medical device. He should store all the clinical files and the patient database in a safe location, such as a server, NAS or CD/DVD and not on the Hard Disk of the medical workstation.

Patient database and clinical files must be backed up periodically. The manufacturer shall not be held liable for damage due to data loss caused by failure to comply with these requirements and with the reference standards.

Data protection

The operator is responsible for the protection of the patient data and the compliance to with the local standards in force. The operator must have appropriate security to prevent the patient data being accidentally or deliberately compromised.

Security software like Firewall and Antivirus programs are necessary if the network environment of the workstation is connected to the Internet or have a connection with external data (USB key or portable HDD).

The operator can contact Acteon Imaging

Customer Service for information about encryption and password protection in the Acteon Imaging software. ,

INTERACTIONS CONTRAINDICATIONS PROHIBITIONS

This includes information relating to the interactions, contraindications and prohibitions known by ACTEON Imaging® on the date on which this document was written.

13.1 INTERFERENCES WITH OTHER MEDICAL DEVICES

Interferences may occur when the system is used on patients fitted with a pacemaker. The medical device presents potential risks due to the emission of electromagnetic fields.

13.2 USING ACCESSORIES NOT SUPPLIED BY ACTEON IMAGING®

The medical device was designed and developed with its accessories to guarantee maximum safety and performance. The use of accessories from another source could put you and your patients at risk and could damage your medical device. Do not try to connect accessories not provided by ACTEON Imaging® to your medical device.

Even if the manufacturer or dealer of your accessory claims full compatibility with ACTEON Imaging® equipment, it is advisable to exercise caution with regards to the origin and safety of the product offered. Look out in particular for lack of information, information in a foreign language, very attractive prices, suspect appearance, mediocre quality or premature wear. If necessary, contact an approved dealer or the ACTEON Imaging® Customer Service.

13.3 PROHIBITED USES

- Do not immerse or use outdoors.
- Do not place the medical device next to a source of heat or in direct sunlight.
- Do not expose the medical device to water spray or mist.

A hot/cold temperature contrast can cause condensation to form in the medical device, which may be dangerous. The medical device may not be stored or used outside the atmospheric pressure and temperature ranges recommended in the User Manual supplied with your medical device.

Do not touch accessible electrical connections.

13.4 MOVING THE MEDICAL DEVICE

After its initial installation, the medical device is not designed to be moved. The medical device must be fixed to ensure that it cannot be removed or moved without the use of a tool. Do not move the medical device during use.

13.5 ASSEMBLY AND DISASSEMBLY

Unless otherwise indicated in the instructions specific to your medical device:

- Control devices are not designed to be removed or disassembled.
- Access doors and/or flaps are not designed to be removed or disassembled.

C E 2460

de Götzen S.r.l • A company of ACTEON Group
Via Roma 45 • 21057 OLGIATE OLONA (VARESE) • ITALY
Tel +39 0331 376 762 • Fax +39 0331 376 763



E-mail: imaging.italysupport@acteongroup.com • www.acteongroup.com